



# Fire resistance test report

Test standard: Sections 2 and 10 of AS 1530.4:2014

Test sponsor: H.B. Fuller Australia

Product: H.B. Fuller Firesound™ sealant



Job number: FRT220130

Test date: 27 June 2023 Revision: R1.1

Warringtonfire: accredited for compliance with ISO/IEC 17025 – Testing



## Quality management

Revision	Date	Information about the report			
R1.0	26 July 2023	Description	Initial issue		
		Name	Prepared by Ryan Dalla Vecchia	Reviewed by Lalson Mathews	Authorised by Patrick Chan
R1.1	1 August 2023	Description	Re-issued to update test specimen orientation, layer details, FRL direction statement, Figure 10 and 11.		
		Name	Prepared by Lalson Mathews	Reviewed by Patrick Chan	Authorised by Patrick Chan
		Signature			

## Executive summary

This report documents the findings of the fire resistance test of control joints in accordance with sections 2 and 10 of AS 1530.4:2014. The testing was done on 27 June 2023.

Warringtonfire performed the test at the request of H.B. Fuller Australia.

Table 1 provides details of the test assembly, and Table 2 provides a summary of the test specimen. A summary of the results is provided in Table 3.

**Table 1 Test assembly**

Item	Detail	
Separating element	Wall system	
Nominal separating element size	Width	1600 mm
	Height	1600 mm
	Thickness East side	142 mm
	West side	116 mm
Number of control joints	Eight	
Restraint conditions	Restrained on all edges	

**Table 2 Test specimen**

Control joint	Control joint type	Aperture size	Wall section	Local fire-stopping protection	Sealant /depth location
A	Vertical	1600 mm high x 20 mm wide	West side	HB Fuller Firesound™ sealant batch # 0001274088	26 mm deep finishing flush with both exposed and non-exposed sides
B	Vertical	1600 mm high x 20 mm wide	East side	HB Fuller Firesound™ sealant batch # 0001274088	26 mm deep finishing flush with both exposed and non-exposed sides
C	Vertical edge	1600 mm high x 20 mm wide	West side	HB Fuller Firesound™ sealant batch # 0001274088	20 mm deep finishing flush with both exposed and non-exposed sides
D	Vertical edge	1600 mm high x 20 mm wide	East side	HB Fuller Firesound™ sealant batch # 0001274088	26 mm deep finishing flush with both exposed and non-exposed sides
E	Sill edge	552 mm long x 20 mm high	West side	HB Fuller Firesound™ sealant batch # 0001274088	20 mm deep finishing flush with both exposed and non-exposed sides
F	Sill edge	1000 mm long x 20 mm high	East side	HB Fuller Firesound™ sealant batch # 0001274088	26 mm deep finishing flush with both exposed and non-exposed sides
G	Head edge	552 mm long x 20 mm high	West side	HB Fuller Firesound™ sealant batch # 0001274088	20 mm deep finishing flush with both exposed and non-exposed sides

Control joint	Control joint type	Aperture size	Wall section	Local fire-stopping protection	Sealant /depth location
					non-exposed sides
H	Head edge	1000 mm long x 20 mm high	East side	HB Fuller Firesound™ sealant batch # 0001274088	26 mm deep finishing flush with both exposed and non-exposed sides

**Table 3 Test results**

Penetration system/control joint	Criteria	Results	Fire resistance level (FRL)
A	Structural adequacy	Not applicable	-/120/120 <sup>^</sup>
	Integrity	No failure at 180 minutes	
	Insulation	Failure at 167 minutes	
B	Structural adequacy	Not applicable	-/180/180
	Integrity	No failure at 180 minutes	
	Insulation	No failure at 180 minutes	
C	Structural adequacy	Not applicable	-/120/120 <sup>^</sup>
	Integrity	No failure at 180 minutes	
	Insulation	Failure at 171 minutes	
D	Structural adequacy	Not applicable	-/180/180
	Integrity	No failure at 180 minutes	
	Insulation	No failure at 180 minutes	
E	Structural adequacy	Not applicable	N/A*
	Integrity	No failure at 180 minutes	
	Insulation	No failure at 180 minutes	
F	Structural adequacy	Not applicable	-/180/180
	Integrity	No failure at 180 minutes	
	Insulation	No failure at 180 minutes	
G	Structural adequacy	Not applicable	N/A*
	Integrity	No failure at 180 minutes	
	Insulation	No failure at 180 minutes	
H	Structural adequacy	Not applicable	-/180/180
	Integrity	No failure at 180 minutes	
	Insulation	No failure at 180 minutes	

**Note:**

“\*” Indicates that no FRL was assigned because of the variations listed in Table 7 in section 3.

“^” The assigned FRL is limited by the expected FRL of the separating element into which it is installed.

## Contents

1.	Introduction	6
2.	Test specimen	6
2.1	Schedule of components	6
2.2	Installation details	11
3.	Test procedure	12
4.	Test measurements and results	13
5.	Application of test results	14
5.1	Test limitations	14
5.2	Variations from the tested specimen	14
5.3	Uncertainty of measurements	14
Appendix A	Drawings of test assembly	15
Appendix B	Test observations	27
Appendix C	Direct field of application	31
Appendix D	Instrumentation locations	33
Appendix E	Test data	36
Appendix F	Photographs	44

## 1. Introduction

This report documents the findings of the fire resistance test of control joints in accordance with sections 2 and 10 of AS 1530.4:2014. The testing was done on 27 June 2023.

Warringtonfire performed the test at the request of the test sponsors listed in Table 4.

**Table 4 Test sponsor details**

Test sponsor	Address
H.B. Fuller Australia	16-22 Redgum Drive Dandenong South VIC 3175 Australia

## 2. Test specimen

### 2.1 Schedule of components

Table 5 describes the test specimen and lists the schedule of components. These were provided by the test sponsor and surveyed by Warringtonfire.

All measurements were done by Warringtonfire – unless indicated otherwise.

Detailed drawings of the test specimen are provided in Appendix A.

**Table 5 Schedule of components**

Item	Description	
<b>Separating element (SE)</b>		
1.	Item name	Wall frame studs
	Product name	Rondo 64 mm steel stud
	Manufacturer	Rondo Building Services Pty Ltd
	Size	64 mm x 36 mm x 0.50BMT
	Batch number	932584200030
	Material	Galvanised steel
2.	Item name	Wall frame tracks
	Product name	Rondo 64 mm steel track
	Manufacturer	Rondo Building Services Pty Ltd
	Size	64 mm x 28 mm x 0.50BMT
	Batch number	932581200019
	Material	Galvanised steel
3.	Item name	Plaster stopping angles
	Product name	Rondo 13 mm plaster stopping angles
	Manufacturer	Rondo Building Services Pty Ltd
	Size	13 mm x 28 mm x 0.40BMT
	Product number	P27
	Material	Galvanised steel
4.	Item name	Fire rated plasterboard
	Product name	13 mm Knauf Firestop® plasterboard
	Manufacturer	Knauf
	Area density	10.8 kg/m <sup>2</sup>

Item	Description	
	size	3000 mm wide x 1200 mm high x 13 mm thick (cut to size)
<b>Fixings</b>		
5.	Item name	Masonry anchors
	Product name	Ø6 x 45 mm masonry anchors – HUS3-M
	Manufacturer / supplier	Hilti
	Material	Galvanised carbon steel
6.	Item name	Plasterboard screws
	Product name	6g x 25 mm, bugle head, needle point screws
	Manufacturer / supplier	Zenith
	Material	Hardened carbon steel
7.	Item name	Plasterboard screws
	Product name	6g x 40 mm, bugle head, needle point screws
	Manufacturer / supplier	Zenith
	Material	Hardened carbon steel
8.	Item name	Plasterboard screws
	Product name	7g x 50 mm, bugle head, needle point screws
	Manufacturer / supplier	Zenith
	Material	Hardened carbon steel
<b>Sealant</b>		
9.	Item name	Fire rated sealant
	Product name	H.B. Fuller Firesound™ sealant
	Manufacturer / supplier	H.B. Fuller Australia
	Density	1600 kg/m <sup>3</sup>
	Batch number	0001274088
<b>Backing rod</b>		
10.	Item name	Backing rod
	Product name	Open cell backing rod
	Supplier	H.B. Fuller Australia
	Material	Polyurethane foam
	Density	27 kg/m <sup>3</sup>
<b>Insulation</b>		
11.	Item name	Cavity insulation batts
	Product name	R1.2 Ecowool acoustic wall batts
	Manufacturer	Ecowool Insulation
	Size	1200 mm long x 600 mm wide x 50 mm thick (cut to suit)
	Density	11 kg/m <sup>3</sup>
	Product code	606005

Item	Description	
SE	Overall size	1200 mm wide × 1200 mm high × 142 mm thick (east side) / 116 mm thick (west side)
	Restraint conditions	Restrained on all edges
	Installation	<p>The wall framing comprised of steel framing with studs (item 1) located along the vertical edges and spaced internally to suit the control joints. The head and sill incorporated wall tracks (item 2). The perimeter framing was masonry anchored (item 5) to the test frame blockwork at nominal 300 mm centres horizontal and 200 mm centres vertical, 100 mm in from the bottom corner. Insulation batts (item 11) were installed in the wall framing cavities between the studs.</p> <p>The west side separating element consisted of two 256 mm wide × 1600 mm high steel frame. They were both clad with two layers of 13 mm thick fire rated plasterboard (item 4) on either side of the steel frame.</p> <p>The east side separating element consisted of two 480 mm wide × 1600 mm high steel frame. They were clad with three layers of 13 mm thick fire rated plasterboard (item 4) on either side of the steel frame.</p> <p>Plasterboard sheets in both sections of separating element finished at a nominal 20 mm distance from the top, bottom and both vertical edges. The gaps between the plasterboard and the surround blockwork were sealed with fire rated sealant (item 9)</p> <p>The first layer of fire rated plasterboard sheets was secured to the steel frame with 25 mm plasterboard screws (item 6), the second layer was secured to the steel frame with 40 mm plasterboard screws ((item 7), and the third layer was secured to the steel frame with 50 mm plasterboard screws (item 6) at 200 mm centres on the perimeter edges and 300 mm in the field. Both sections of separating element were separated by three layers of 16 mm thick fire rated plasterboard.</p> <p>See Figure 1 to Figure 12 in Appendix A for more details.</p>
<b>Control joint A (West side)</b>		
A	Aperture size	1600 mm high × 20 mm wide
	Control joint sealant thickness	26 mm deep on both side
	Local fire-stopping protection	
	Protection	Two plaster stopping angles (item 3) were stapled to the 13 mm plasterboard on both vertical edges of the aperture on both exposed and unexposed sides. An open cell backing rod (item 10) was inserted into the aperture to a depth of 26 mm from both the exposed and unexposed sides of the separating element. Fire rated sealant (item 9) was then applied onto the open cell backing rod and finished flush with the exposed and unexposed faces of the separating element.
<b>Control joint B (East side)</b>		
B	Aperture size	1600 mm high × 20 mm wide
	Control joint mastic thickness	26 mm deep on both sides
	Local fire-stopping protection	
	Protection	Two plaster stopping angles (item 3) were stapled to the 13 mm plasterboard on both vertical edges of the aperture on both exposed and unexposed sides. An open cell backing rod (item 10) was inserted into the aperture to a depth of 26 mm from both the exposed and unexposed faces of the separating element. Fire rated sealant (item 9) was then applied onto the open cell



Item	Description	
		backing rod and finished flush with the exposed and unexposed faces of the separating element.
<b>Control joint C (Westside vertical edge)</b>		
<b>C</b>	Aperture size	1600 mm high x 20 mm wide
	Control joint mastic thickness	20 mm deep on both sides
	Local fire-stopping protection	
	Protection	One plaster stopping angle (item 3) was stapled to the 13 mm plasterboard on the vertical edges of the aperture on both exposed and unexposed sides. An open cell backing rod (item 10) was inserted into the aperture to a depth of 20 mm from both the exposed and unexposed faces of the separating element. Fire rated sealant (item 9) was then applied onto the open cell backing rod and finished flush with the exposed and unexposed faces of the separating element.
<b>Control joint D (East side vertical edge)</b>		
<b>D</b>	Aperture size	1600 mm high x 20 mm wide
	Control joint mastic thickness	26 mm deep on both sides
	Local fire-stopping protection	
	Protection	One plaster stopping angle (item 3) was stapled to the 13 mm plasterboard on the vertical edges of the aperture on both exposed and unexposed sides. An open cell backing rod (item 10) was inserted into the aperture to a depth of 26 mm from both the exposed and unexposed faces of the separating element. Fire rated sealant (item 9) was then applied onto the open cell backing rod and finished flush with the exposed and unexposed faces of the separating element.
<b>Control joint E (West side sill)</b>		
<b>E</b>	Aperture size	552 mm long x 20 mm high
	Control joint mastic thickness	20 mm deep on both sides
	Local fire-stopping protection	
	Protection	One plaster stopping angle (item 3) was stapled to the 13 mm plasterboard on the horizontal edges of the aperture on both exposed and unexposed sides. An open cell backing rod (item 10) was inserted into the aperture to a depth of 20 mm from both the exposed and unexposed faces of the separating element. Fire rated sealant (item 9) was then applied onto the open cell backing rod and finished flush with the exposed and unexposed faces of the separating element.
<b>Control joint F (East side sill)</b>		
<b>F</b>	Aperture size	1000 mm long x 20 mm high
	Control joint mastic thickness	26 mm deep on both sides
	Local fire-stopping protection	
	Protection	One plaster stopping angle (item 3) was stapled to the 13 mm plasterboard on the horizontal edges of the aperture on both exposed and unexposed sides. An open cell backing rod (item 10) was inserted into the aperture to a depth of

Item	Description	
		26 mm from both the exposed and unexposed faces of the separating element. Fire rated sealant (item 9) was then applied onto the open cell backing rod and finished flush with the exposed and unexposed faces of the separating element.
<b>Control joint G (West side head)</b>		
<b>G</b>	Aperture size	552 mm long x 20 mm high
	Control joint mastic thickness	20 mm deep on both sides
	Local fire-stopping protection	
	Protection	One plaster stopping angle (item 3) was stapled to the 13 mm plasterboard on the horizontal edges of the aperture on both exposed and unexposed sides. An open cell backing rod (item 10) was inserted into the aperture to a depth of 20 mm from both the exposed and unexposed faces of the separating element. Fire rated sealant (item 9) was then applied onto the open cell backing rod and finished flush with the exposed and unexposed faces of the separating element.
<b>Control joint H (East side head)</b>		
<b>H</b>	Aperture size	1000 mm long x 20 mm high
	Control joint mastic thickness	26 mm deep on both sides
	Local fire-stopping protection	
	Protection	One plaster stopping angle (item 3) was stapled to the 13 mm plasterboard on the horizontal edges of the aperture on both exposed and unexposed sides. An open cell backing rod (item 10) was inserted into the aperture to a depth of 26 mm from both the exposed and unexposed faces of the separating element. Fire rated sealant (item 9) was then applied onto the open cell backing rod and finished flush with the exposed and unexposed faces of the separating element.

## 2.2 Installation details

Table 6 lists the installation details for the test specimen.

**Table 6 Installation details**

Item	Detail
Start date for construction of separating element	11 May 2023
Start date for installation of fire-stopping protection for the control joints	30 May 2023
Completion date for constructing and installing the test specimen	30 May 2023
Separating element constructed by	Representatives of Warringtonfire
Fire-stopping protection for penetration control joints installed by	Representatives of the test sponsor
Symmetry	Symmetrical

### 3. Test procedure

Table 7 details the test procedure for this fire resistance test.

**Table 7 Test procedure**

Item	Detail	
Statement of compliance	The test was performed in accordance with the requirements of sections 2 and 10 of AS 1530.4:2014 appropriate for control joints.	
Variations	<ul style="list-style-type: none"> <li>Control joint E and G were shorter than the full length specified in clause 10.4.2 of AS 1530.4:2014.</li> </ul>	
Pre-test conditioning	The assembly of the test specimen was completed on 30 May 2023. The test specimen was subjected to normal laboratory temperatures and conditions between the completion of assembly of the test specimen and the start of the test.	
Sampling / specimen selection	<p>The laboratory was not involved in sampling or selecting the test specimen for the fire resistance test.</p> <p>The results obtained during the test only apply to the test samples as received and tested by Warringtonfire.</p>	
Ambient laboratory temperature	Start of the test	14 °C
	Minimum temperature	14 °C
	Maximum temperature	18 °C
Test duration	181 minutes	
Instrumentation and equipment	<p>The instrumentation was provided in accordance with AS 1530.4:2014 as follows:</p> <ul style="list-style-type: none"> <li>The furnace temperature was measured by four mineral insulated metal sheathed (MIMS) Type K thermocouples – with wire diameters not greater than 1 mm, an overall diameter of 3 mm, and the measuring junction insulated from the sheath. The thermocouples protruded a minimum of 25 mm from steel supporting tubes.</li> <li>The unexposed side specimen temperatures were measured by Type K thermocouples with wire diameters less than 0.5 mm soldered to 12 mm diameter x 0.2 mm thick copper discs covered by 30 mm x 30 mm x 2.0 mm thick inorganic insulating pads.</li> <li>The thermocouple positions are shown in Table 10 and in Figure 13 in Appendix D.</li> <li>A roving thermocouple was available to measure temperatures at positions that appeared hotter than the positions monitored by the fixed thermocouples.</li> <li>Cotton pads were available during the test to assess the performance of the specimen under the criteria of integrity.</li> <li>The furnace pressure was measured at approximately the mid height of the vertical control joint</li> </ul>	

## 4. Test measurements and results

Table 8 summarises the results the specimen achieved against the performance criteria listed in sections 2 and 10 of AS 1530.4:2014.

Appendix E includes details of the measurements taken during the test.

Table 9 in Appendix B includes observations of any significant behaviour of the specimen and details of the occurrence of the various performance criteria specified in AS 1530.4:2014.

Appendix D includes instrumentation details of the specimen.

Photographs of the specimen are included in Appendix F.

**Table 8 Test results**

control joint	Criteria	Results	Fire resistance level (FRL)
A	Structural adequacy	Not applicable	-/120/120 <sup>^</sup>
	Integrity	No failure at 180 minutes	
	Insulation	Failure at 167 minutes	
B	Structural adequacy	Not applicable	-/180/180
	Integrity	No failure at 180 minutes	
	Insulation	No failure at 180 minutes	
C	Structural adequacy	Not applicable	-/120/120 <sup>^</sup>
	Integrity	No failure at 180 minutes	
	Insulation	Failure at 171 minutes	
D	Structural adequacy	Not applicable	-/180/180
	Integrity	No failure at 180 minutes	
	Insulation	No failure at 180 minutes	
E	Structural adequacy	Not applicable	N/A*
	Integrity	No failure at 180 minutes	
	Insulation	No failure at 180 minutes	
F	Structural adequacy	Not applicable	-/180/180
	Integrity	No failure at 180 minutes	
	Insulation	No failure at 180 minutes	
G	Structural adequacy	Not applicable	N/A*
	Integrity	No failure at 180 minutes	
	Insulation	No failure at 180 minutes	
H	Structural adequacy	Not applicable	-/180/180
	Integrity	No failure at 180 minutes	
	Insulation	No failure at 180 minutes	

**Note:**

“\*\*” Indicates that no FRL was assigned because of the variations listed in Table 7 in section 3.

“^” The assigned FRL is limited by the expected FRL of the separating element into which it is installed.

## 5. Application of test results

### 5.1 Test limitations

The results of these fire tests may be used to directly assess fire hazard, but it should be recognised that a single test method will not provide a full assessment of fire hazard under all fire conditions.

These results only relate to the behaviour of the specimen of the element of construction under the particular conditions of the test. They are not intended to be the sole criteria for assessing the potential fire performance of the element in use, and they do not necessarily reflect the actual behaviour in fires.

### 5.2 Variations from the tested specimen

This report details methods of construction, the test conditions and the results obtained when the specific element of construction described here was tested following the procedure outlined in AS 1530.4:2014. Any significant variation with respect to size, construction details, loads, stresses, edge or end conditions, other than that allowed under the field of direct application in the relevant test method, is not covered by this report.

It is recommended that any proposed variation to the tested configuration – other than as permitted under the field of direct application specified in Appendix C – should be referred to the test sponsor. They should then obtain appropriate documentary evidence of compliance from Warringtonfire or another accredited testing authority.

### 5.3 Uncertainty of measurements

Because of the nature of fire resistance testing and the consequent difficulty in quantifying the uncertainty of measurement of fire resistance, it is not possible to provide a stated degree of accuracy for the result.

## Appendix A Drawings of test assembly

The leaders in the drawings represent the items listed in section 2.1. All measurements – unless indicated – are in millimetres.

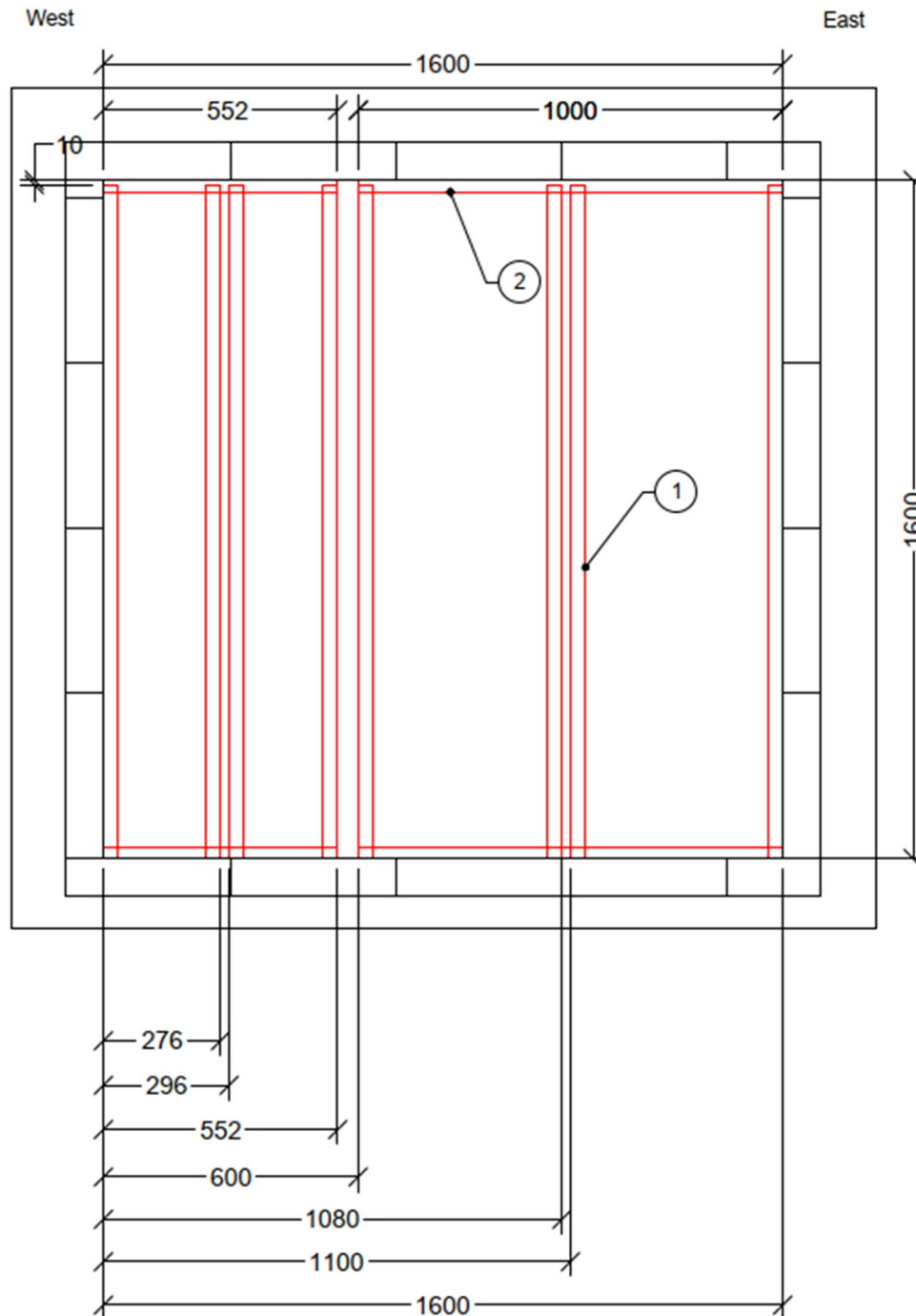

Figure 1 Elevation view of steel framing (unexposed side)

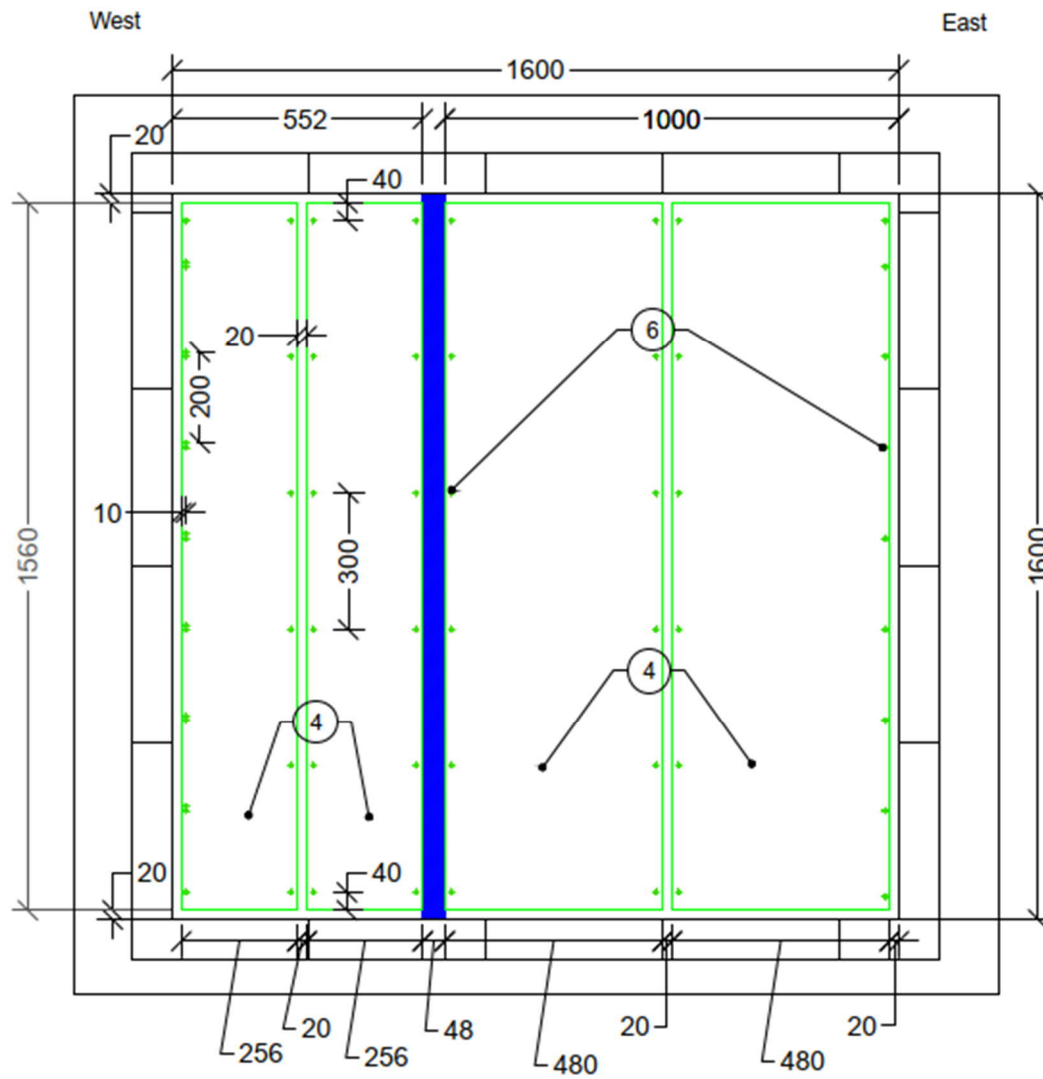

Figure 2 Elevation view of the first layer of plaster board (unexposed side)



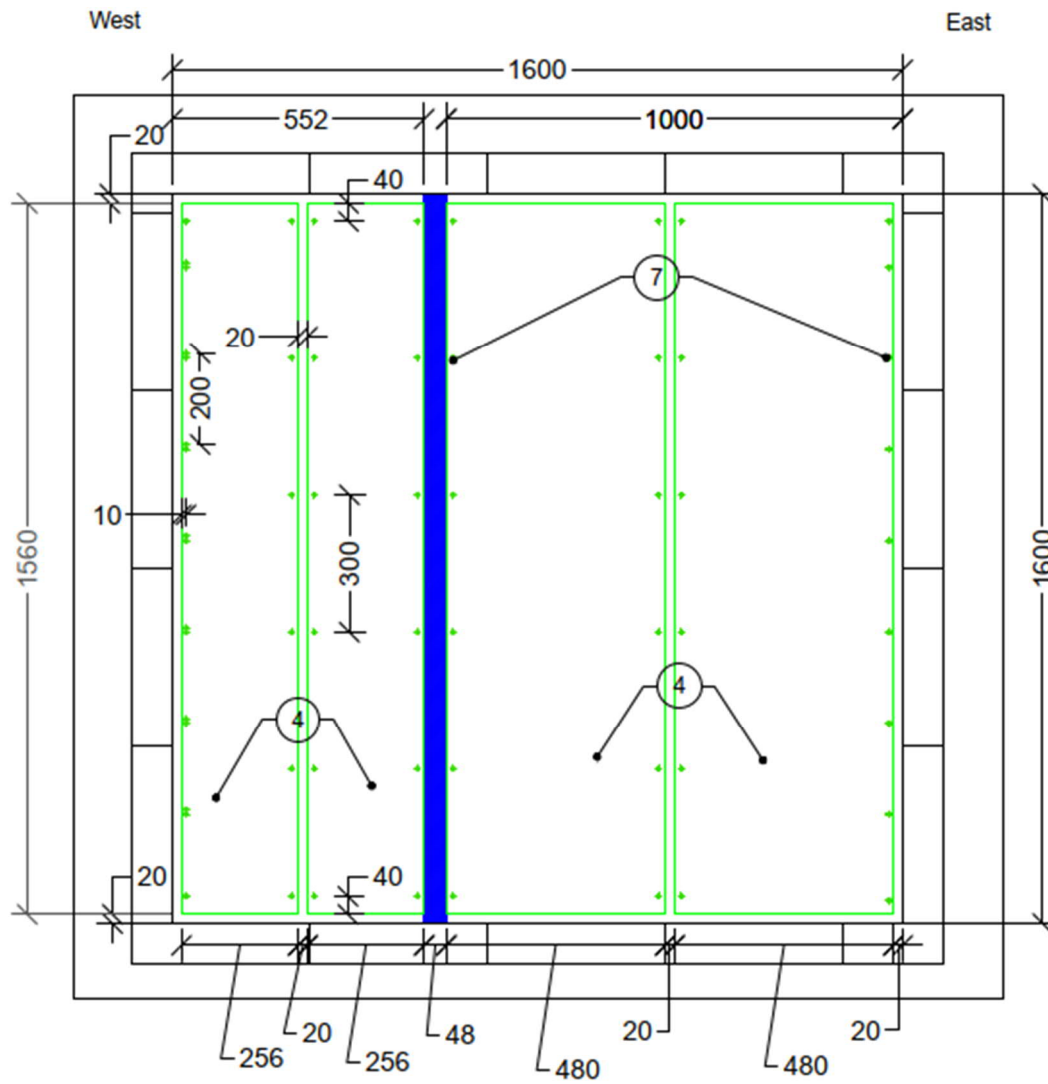

Figure 3 Elevation view of the second layer of plaster board (unexposed side)

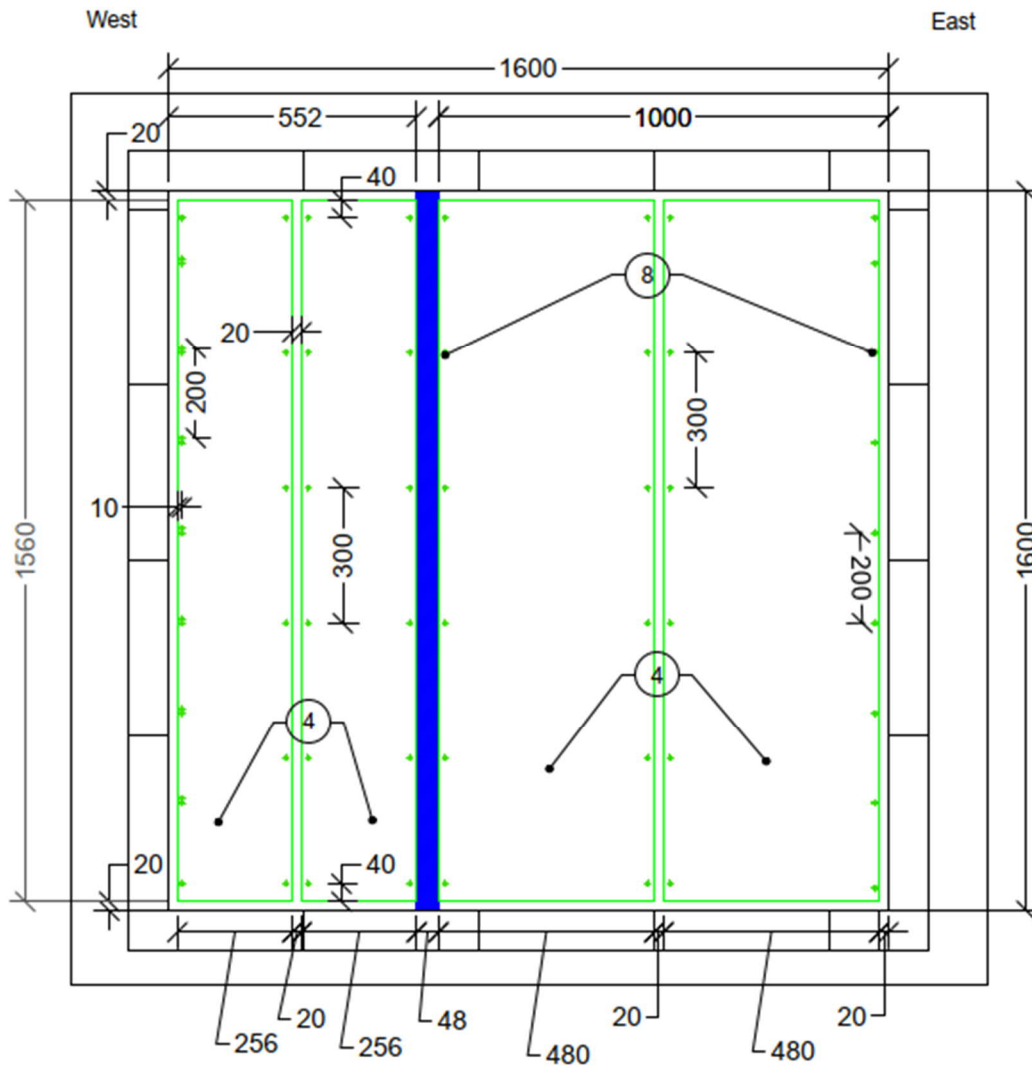

Figure 4 Elevation view of the third layer of plaster board (unexposed side)



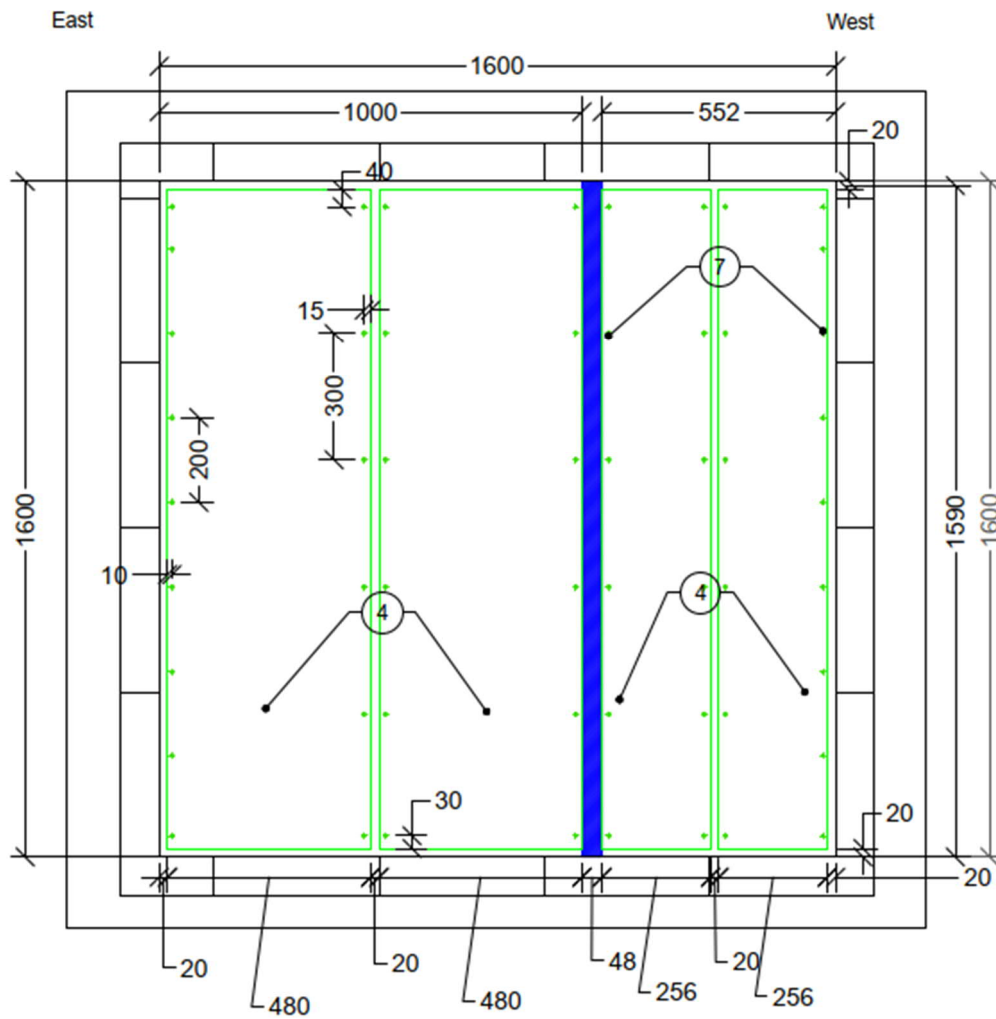

Figure 6 Elevation view of the second layer of plaster board (exposed side)

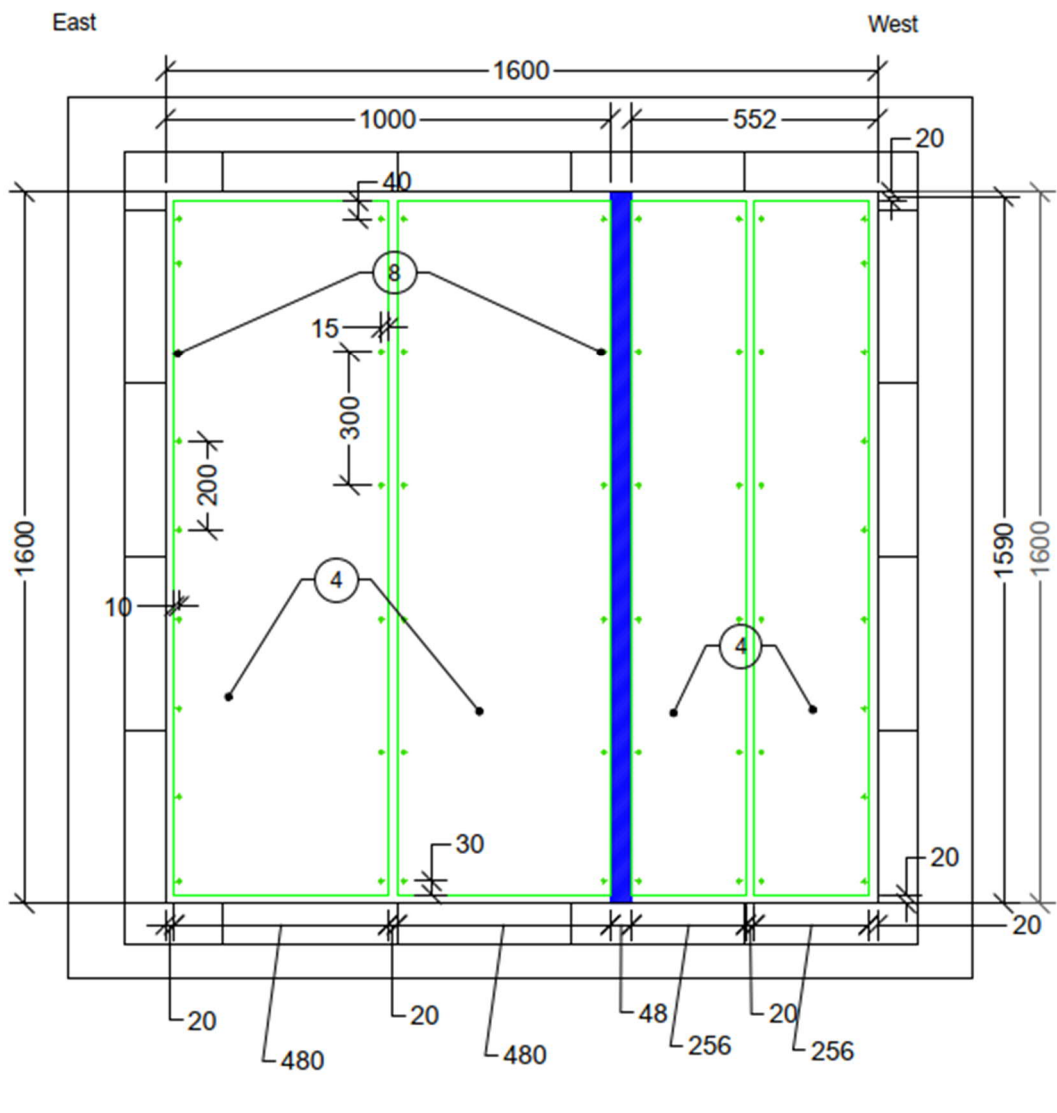

Figure 7 Elevation view of the third layer of plaster board (exposed side)

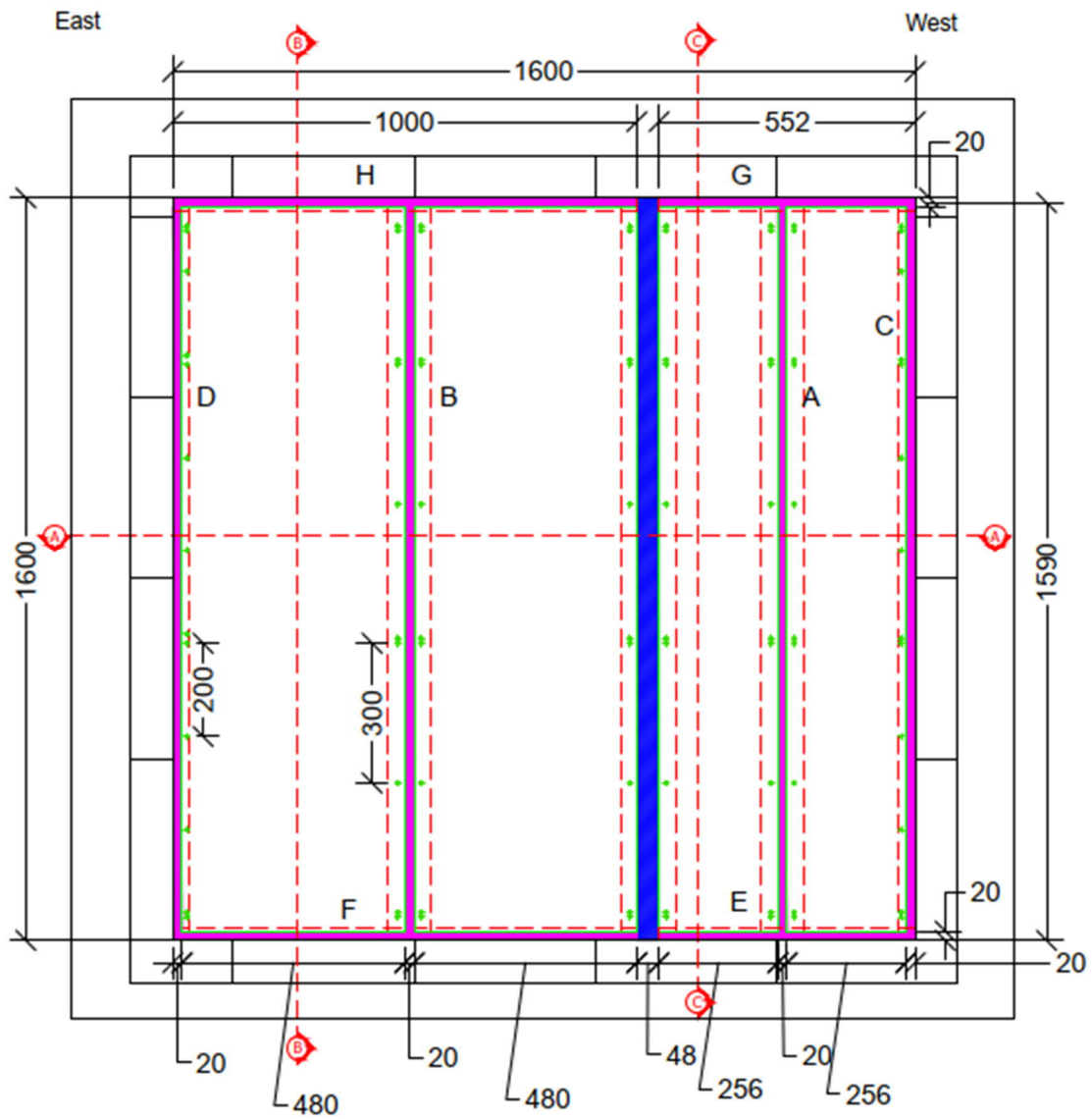

Figure 8 Elevation view of specimen (exposed side)

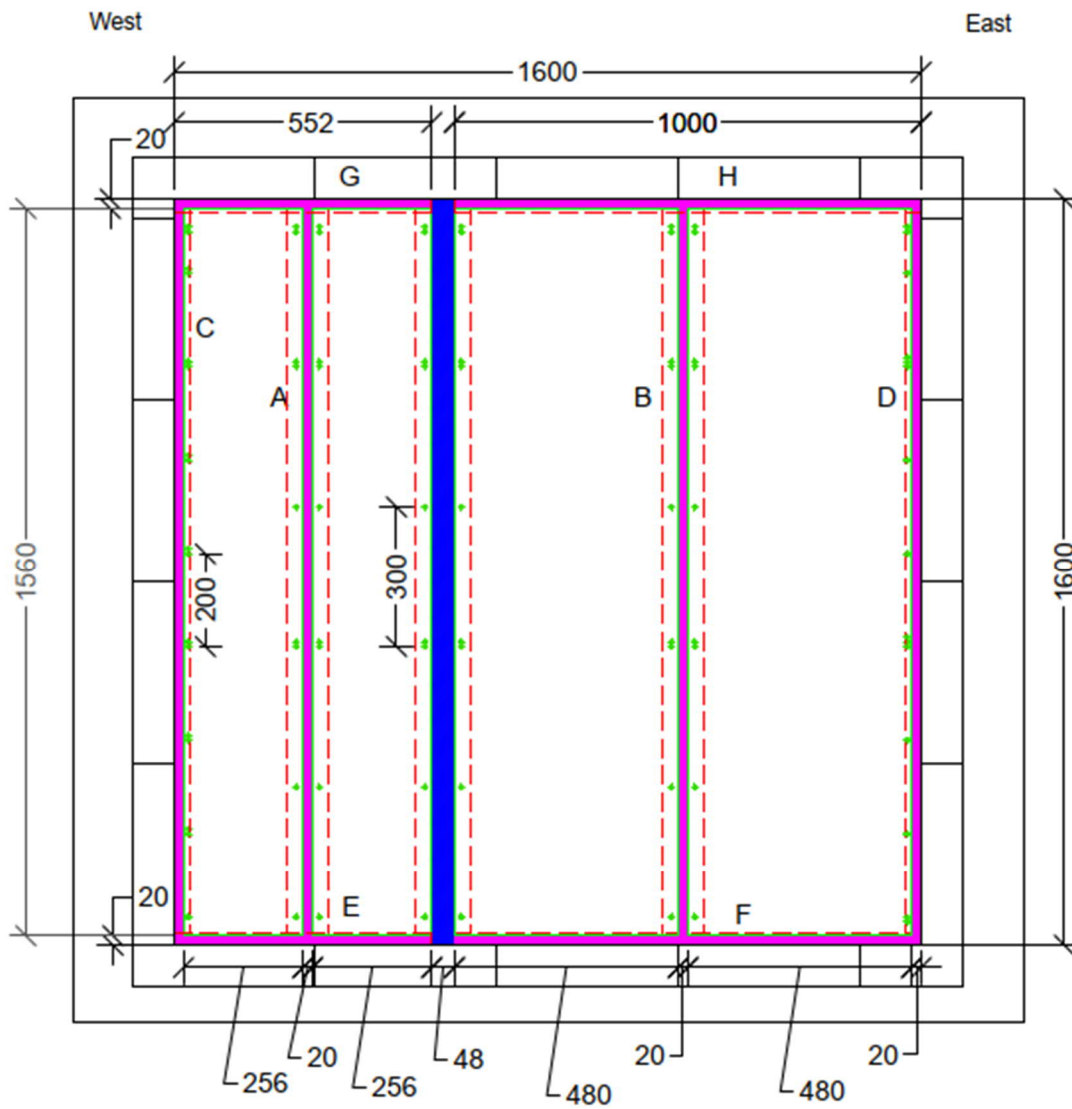

Figure 9 Elevation view of specimen (unexposed side)

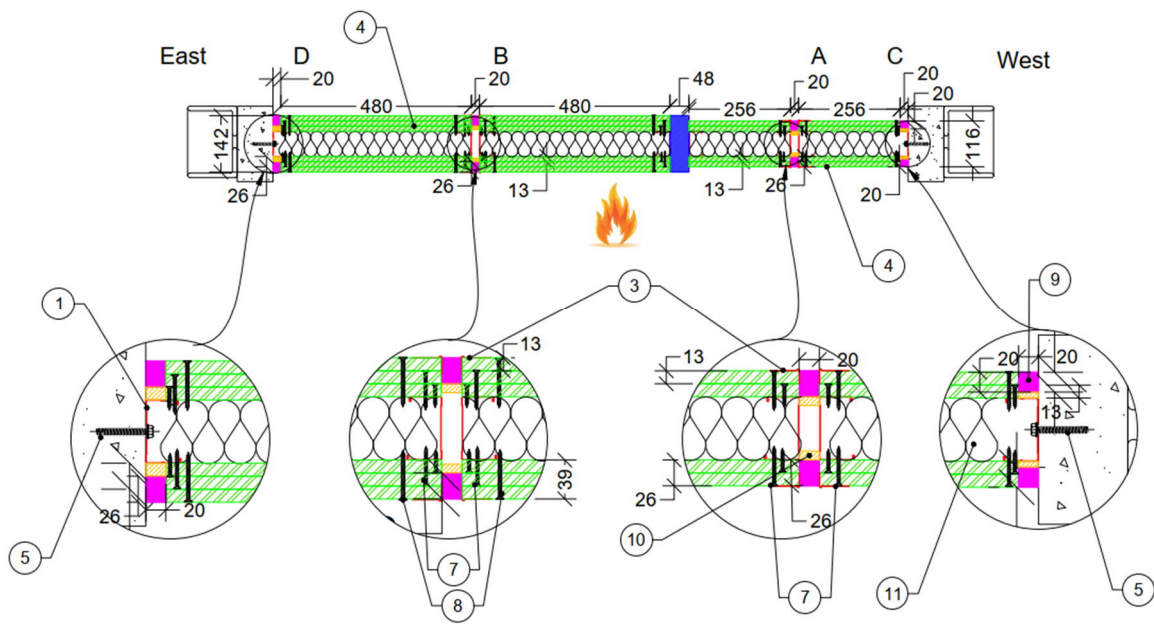

Figure 10 Cross-section A-A



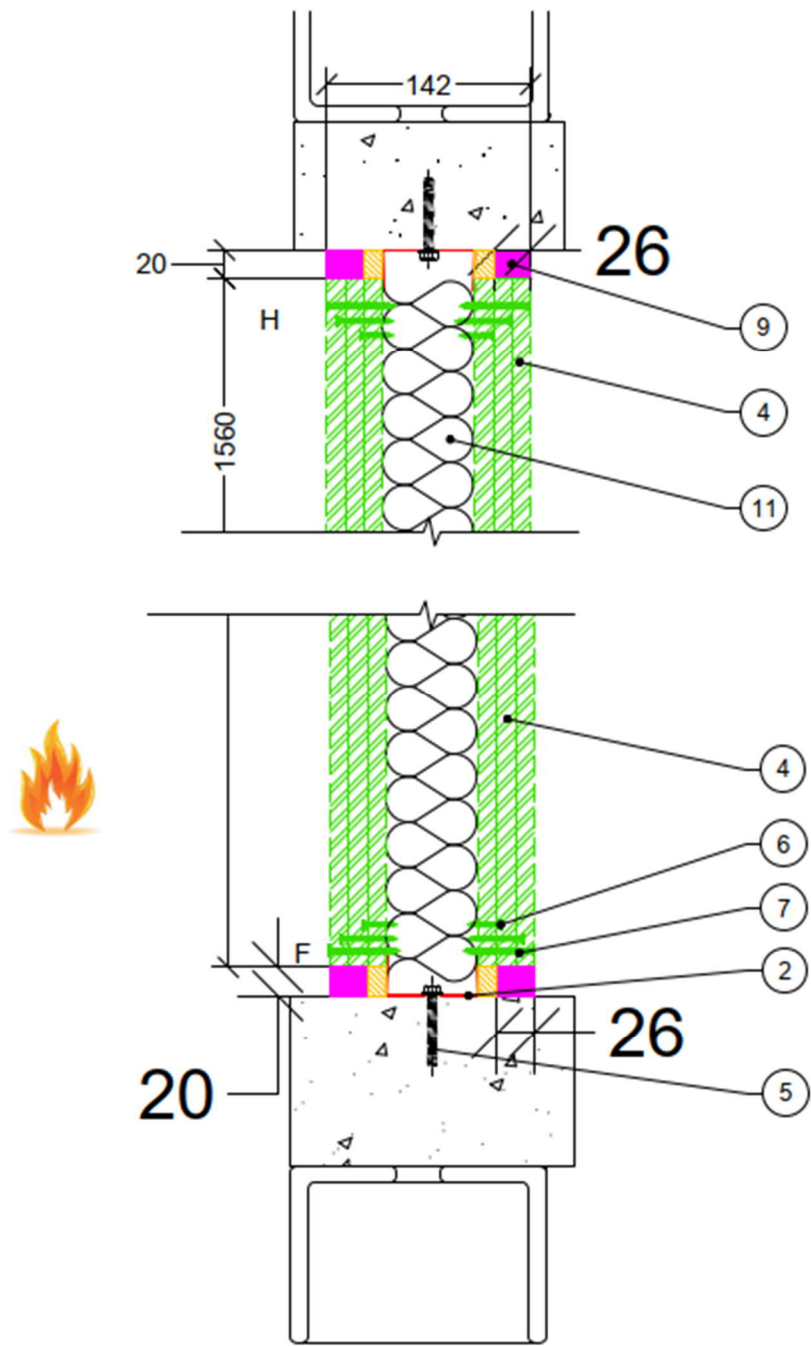

Figure 11 Cross-section B-B

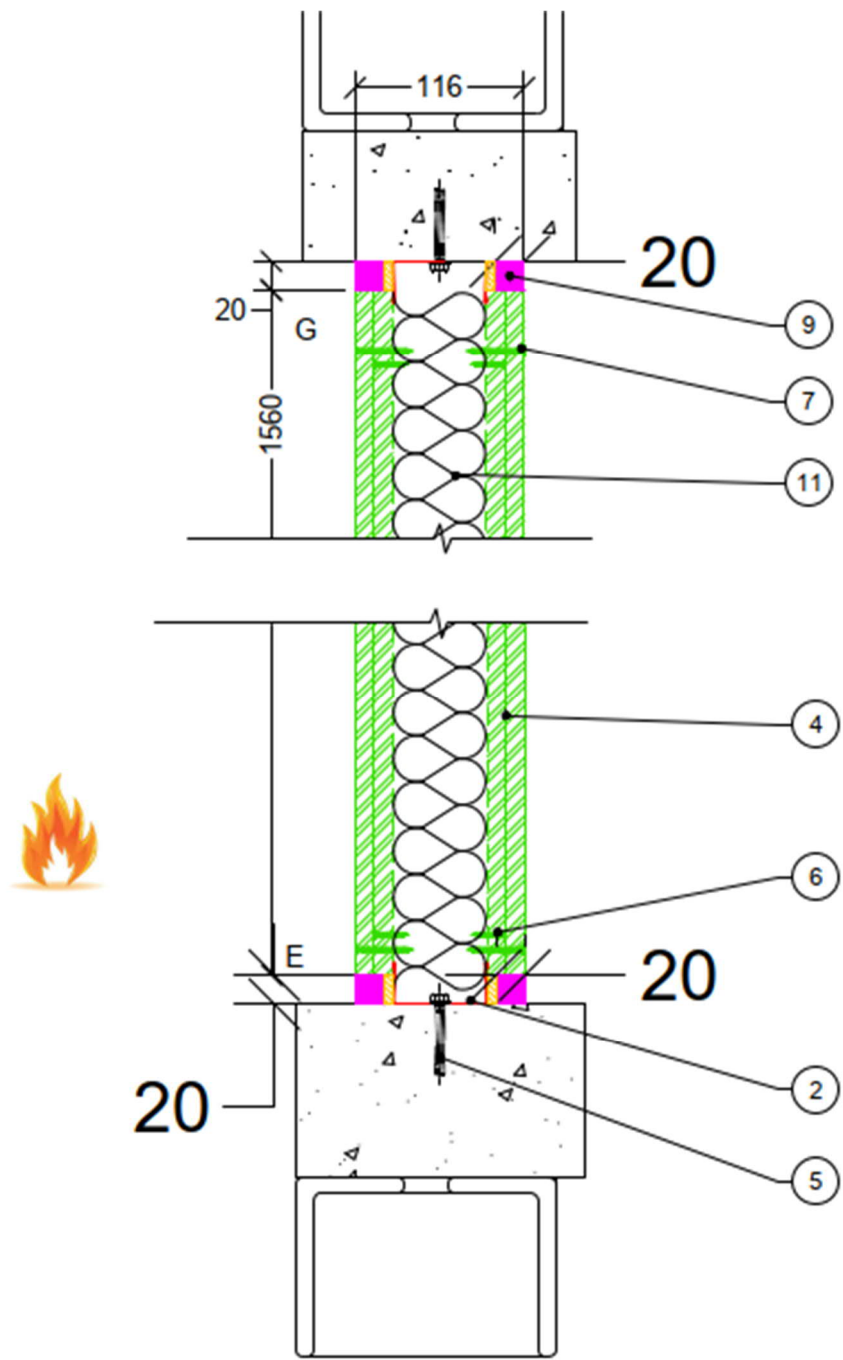

Figure 12 Cross-section C-C

## Appendix B Test observations

Table 9 shows the observations of any significant behaviour of the specimen during the test.

**Table 9 Test observations**

Time		Observation
Min	Sec	
<b>Penetration system A</b>		
00	00	The fire resistance test started. The initial temperature of the test specimen was approximately 14 °C
15	00	The test specimen continued to maintain integrity and insulation in accordance with AS 1530.4:2014.
30	00	The test specimen continued to maintain integrity and insulation in accordance with AS 1530.4:2014.
45	00	The test specimen continued to maintain integrity and insulation in accordance with AS 1530.4:2014.
56	50	A crack occurred in the control joint near TC003
60	00	The test specimen continued to maintain integrity and insulation in accordance with AS 1530.4:2014.
90	00	The test specimen continued to maintain integrity and insulation in accordance with AS 1530.4:2014.
120	00	The test specimen continued to maintain integrity and insulation in accordance with AS 1530.4:2014.
168	00	<b>TC006 on the separating element recorded a temperature of 194 °C. Failure of insulation in accordance with clause 2.13.3(b) of AS 1530.4:2014, where the maximum temperature of thermocouple TC006 exceeded the initial temperature by more than 180 K.</b>
180	00	The test specimen continued to maintain integrity in accordance with AS 1530.4:2014.
181	00	Test Stopped
<b>Penetration system B</b>		
00	00	The fire resistance test started. The initial temperature of the test specimen was approximately 14 °C
15	00	The test specimen continued to maintain integrity and insulation in accordance with AS 1530.4:2014.
30	00	The test specimen continued to maintain integrity and insulation in accordance with AS 1530.4:2014.
45	00	The test specimen continued to maintain integrity and insulation in accordance with AS 1530.4:2014.
60	00	The test specimen continued to maintain integrity and insulation in accordance with AS 1530.4:2014.
90	00	The test specimen continued to maintain integrity and insulation in accordance with AS 1530.4:2014.
120	00	The test specimen continued to maintain integrity and insulation in accordance with AS 1530.4:2014.
180	00	The test specimen continued to maintain integrity and insulation in accordance with AS 1530.4:2014.
181	00	Test stopped

Time		Observation
Min	Sec	
<b>Penetration system C</b>		
00	00	The fire resistance test started. The initial temperature of the test specimen was approximately 14 °C
15	00	The test specimen continued to maintain integrity and insulation in accordance with AS 1530.4:2014.
30	00	The test specimen continued to maintain integrity and insulation in accordance with AS 1530.4:2014.
45	00	The test specimen continued to maintain integrity and insulation in accordance with AS 1530.4:2014.
60	00	The test specimen continued to maintain integrity and insulation in accordance with AS 1530.4:2014.
90	00	The test specimen continued to maintain integrity and insulation in accordance with AS 1530.4:2014.
120	00	The test specimen continued to maintain integrity and insulation in accordance with AS 1530.4:2014.
171	30	<b>TC016 on the separating element recorded a temperature of 194 °C. Failure of insulation in accordance with clause 2.13.3(b) of AS 1530.4:2014, where the maximum temperature of thermocouple TC016 exceeded the initial temperature by more than 180 K.</b>
180	00	The test specimen continued to maintain integrity in accordance with AS 1530.4:2014.
181	00	Test stopped
<b>Penetration system D</b>		
00	00	The fire resistance test started. The initial temperature of the test specimen was approximately 14 °C
05	30	Smoke emitting from between the blockwork framing approximately at the lower quarter point of the control joint.
15	00	The test specimen continued to maintain integrity and insulation in accordance with AS 1530.4:2014.
30	00	The test specimen continued to maintain integrity and insulation in accordance with AS 1530.4:2014.
45	00	The test specimen continued to maintain integrity and insulation in accordance with AS 1530.4:2014.
60	00	The test specimen continued to maintain integrity and insulation in accordance with AS 1530.4:2014.
86	00	TC024 was not touching the control joint and was pushed in so that it was touching
90	00	The test specimen continued to maintain integrity and insulation in accordance with AS 1530.4:2014.
120	00	The test specimen continued to maintain integrity and insulation in accordance with AS 1530.4:2014.
135	00	TC024 was not touching the control joint and was pushed in so that it was touching
180	00	The test specimen continued to maintain integrity and insulation in accordance with AS 1530.4:2014.
181	00	Test stopped

Time		Observation
Min	Sec	
<b>Penetration system E</b>		
00	00	The fire resistance test started. The initial temperature of the test specimen was approximately 14 °C
15	00	The test specimen continued to maintain integrity and insulation in accordance with AS 1530.4:2014.
30	00	The test specimen continued to maintain integrity and insulation in accordance with AS 1530.4:2014.
45	00	The test specimen continued to maintain integrity and insulation in accordance with AS 1530.4:2014.
60	00	The test specimen continued to maintain integrity and insulation in accordance with AS 1530.4:2014.
90	00	The test specimen continued to maintain integrity and insulation in accordance with AS 1530.4:2014.
114	10	Crack in the control joint near TC031
120	00	The test specimen continued to maintain integrity and insulation in accordance with AS 1530.4:2014.
144	50	Discolouration in the plasterboard near TC031
154	12	Roving thermocouple applied near crack in the control join of TC031
180	00	The test specimen continued to maintain integrity and insulation in accordance with AS 1530.4:2014.
181	00	Test stopped
<b>Penetration system F</b>		
00	00	The fire resistance test started. The initial temperature of the test specimen was approximately 14 °C
15	00	The test specimen continued to maintain integrity and insulation in accordance with AS 1530.4:2014.
30	00	The test specimen continued to maintain integrity and insulation in accordance with AS 1530.4:2014.
45	00	The test specimen continued to maintain integrity and insulation in accordance with AS 1530.4:2014.
60	00	The test specimen continued to maintain integrity and insulation in accordance with AS 1530.4:2014.
86	00	TC031 was not touching the control joint and was pushed in so that it was touching
90	00	The test specimen continued to maintain integrity and insulation in accordance with AS 1530.4:2014.
120	000	The test specimen continued to maintain integrity and insulation in accordance with AS 1530.4:2014.
135	00	TC031 was not touching the control joint and was pushed in so that it was touching
154	40	Smoke emitting from crack on the control joint near TC31
180	00	The test specimen continued to maintain integrity and insulation in accordance with AS 1530.4:2014.
181	00	Test stopped

Time		Observation
Min	Sec	
<b>Penetration system G</b>		
00	00	The fire resistance test started. The initial temperature of the test specimen was approximately 14 °C
2	50	Minimal amount of smoke emitting through the sealant.
15	00	The test specimen continued to maintain integrity and insulation in accordance with AS 1530.4:2014.
30	00	The test specimen continued to maintain integrity and insulation in accordance with AS 1530.4:2014.
45	00	The test specimen continued to maintain integrity and insulation in accordance with AS 1530.4:2014.
60	00	The test specimen continued to maintain integrity and insulation in accordance with AS 1530.4:2014.
90	00	The test specimen continued to maintain integrity and insulation in accordance with AS 1530.4:2014.
120	00	The test specimen continued to maintain integrity and insulation in accordance with AS 1530.4:2014.
180	00	The test specimen continued to maintain integrity and insulation in accordance with AS 1530.4:2014.
181	00	Test stopped
<b>Penetration system H</b>		
00	00	The fire resistance test started. The initial temperature of the test specimen was approximately 14 °C
15	00	The test specimen continued to maintain integrity and insulation in accordance with AS 1530.4:2014.
30	00	The test specimen continued to maintain integrity and insulation in accordance with AS 1530.4:2014.
45	00	The test specimen continued to maintain integrity and insulation in accordance with AS 1530.4:2014.
60	00	The test specimen continued to maintain integrity and insulation in accordance with AS 1530.4:2014.
90	00	The test specimen continued to maintain integrity and insulation in accordance with AS 1530.4:2014.
120	00	The test specimen continued to maintain integrity and insulation in accordance with AS 1530.4:2014.
180	00	The test specimen continued to maintain integrity and insulation in accordance with AS 1530.4:2014.
181	00	Test stopped

## Appendix C Direct field of application

The text, figures and tables in this appendix have been taken from section 10 of AS 1530.4:2014.

### C.1 General

The results of the fire test contained in the test report are directly applicable without reference to the testing authority to similar constructions where one or more of the changes set out in clauses 10.12.2 to 10.12.6 of AS 1530.4:2014 have been made.

### C.2 Separating elements

Results obtained for sealing systems in various types of masonry and concrete construction may be applied as follows:

- For elements manufactured from similar types of concrete or masonry, the results of the prototype test may be applied to materials of density within  $\pm 15\%$  of the tested specimen. For greater variations, the opinion of a registered testing authority shall be obtained.
- Test results obtained in conjunction with hollow concrete blocks may be used in a solid concrete element of the same overall thickness. The reverse does not apply.
- Results obtained from framed wall systems may be applied to the performance of a system in concrete, masonry or solid gypsum blocks of greater or equal thickness to that of the tested prototype. The reverse does not apply.
- Results obtained from framed wall systems may be applied to similar walls having studs of the same material with sizes greater than the tested prototype.
- Results obtained from a prototype test may be applied to framed wall systems of similar construction but having thicker facings of the same material applied to the studs.

### C.3 Control joints

The following variations are permitted:

- Results obtained from single test on a butt joints may be applied to contoured joints, provided the joints have —
  - equal width and equal or greater depth of sealant; and
  - equal or greater thickness of fire-separating element.
  - Note: Examples of butt and contoured control joints are shown in figure 10.12.6 of AS 1530.4:2014.
- Facings may be applied to the surface of the fire-stopping system.

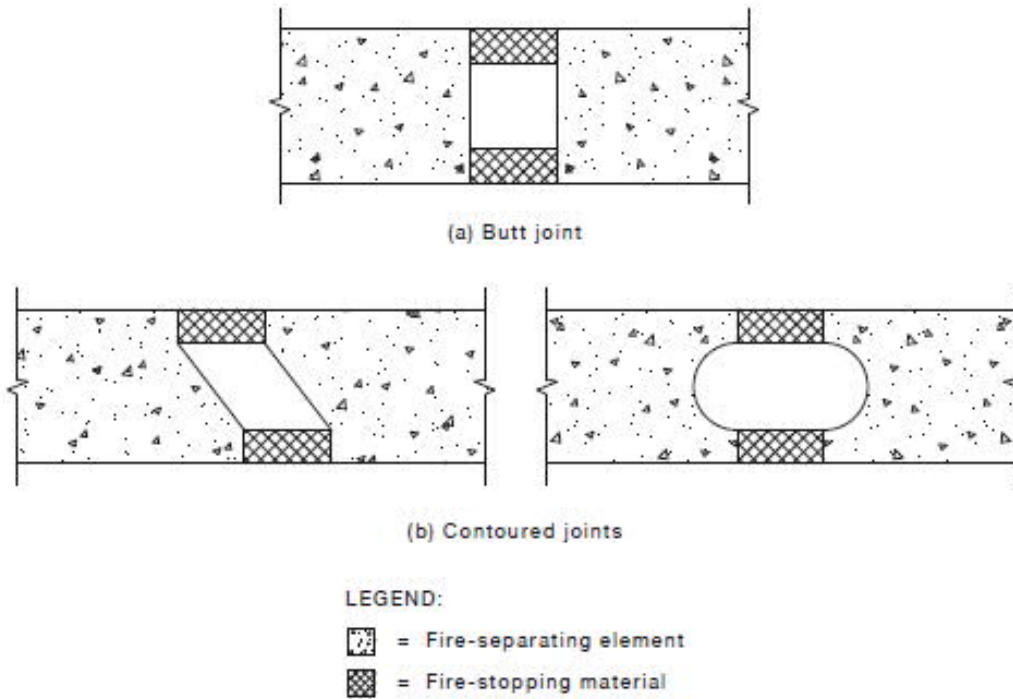

FIGURE 10.12.6 CONTOURED CONTROL JOINTS



## Appendix D Instrumentation locations



Figure 13 Thermocouple location

**Table 10 Thermocouple locations**

Penetration system / control joint	T/C #	Description
A	001	On the control joint, 400 mm up from the centre.
	002	On the control joint, at the centre.
	003	On the control joint, 400 mm down from the centre.
	004	25 mm west from the control joint, 600 mm up from the centre.
	005	25 mm west from the control joint, 200 mm down from the centre.
	006	25 mm east from the control joint, 200 mm up from the centre.
	007	25 mm east from the control joint, 600 mm down from the centre.
B	008	On the control joint, 400 mm up from the centre.
	009	On the control joint, at the centre.
	010	On the control joint, 400 mm down from the centre.
	011	25 mm west from the control joint, 600 mm up from the centre.
	012	25 mm west from the control joint, 200 mm down from the centre.
	013	25 mm east from the control joint, 200 mm up from the centre.
	014	25 mm east from the control joint, 600 mm down from the centre.
C	015	On the control joint, 400 mm up from the centre.
	016	On the control joint, at the centre.
	017	On the control joint, 400 mm down from the centre.
	018	25 mm from the control joint, 600 mm up from the centre on the plasterboard.
	019	25 mm from the control joint, 200 mm down from the centre on the plasterboard.
	020	25 mm from the control joint, 200 mm up from the centre on the brick.
	021	25 mm from the control joint, 600 mm down from the centre on the brick.
D	022	On the control joint, 400 mm up from the centre.
	023	On the control joint, at the centre.
	024	On the control joint, 400 mm down from the centre.
	025	25 mm from the control joint, 600 mm up from the centre on the plasterboard.
	026	25 mm from the control joint, 200 mm down from the centre on the plasterboard.
	E	029
030		On the control joint, at the centre. (128 mm)
031		On the control joint, 130 mm east from the centre.
032		25 mm up from the control joint, 60 mm west from the centre on the plasterboard.
033		25 mm up the control joint, 200 mm east from the centre on the plasterboard.
F	036	On the control joint, 250 mm west from the centre.
	037	On the control joint, at the centre. (240 mm)
	038	On the control joint, 250 mm east from the centre.
	039	25 mm up from the control joint, 125 mm west from the centre on the plasterboard.
	040	25 mm up the control joint, 375 mm east from the centre on the plasterboard.
G	043	On the control joint, 130 mm west from the centre.
	044	On the control joint, at the centre.

Penetration system / control joint	T/C #	Description
	045	On the control joint, 130 mm east from the centre.
	046	25 mm down from the control joint, 60 mm west from the centre on the plasterboard.
	047	25 mm down the control joint, 200 mm east from the centre on the plasterboard.
H	050	On the control joint, 250 mm west from the centre.
	051	On the control joint, at the centre.
	052	On the control joint, 250 mm east from the centre.
	053	25 mm down from the control joint, 125 mm west from the centre on the plasterboard.
	054	25 mm down from the control joint, 375 mm east from the centre on the plasterboard.

## Appendix E Test data

### E.1 Furnace temperature and severity

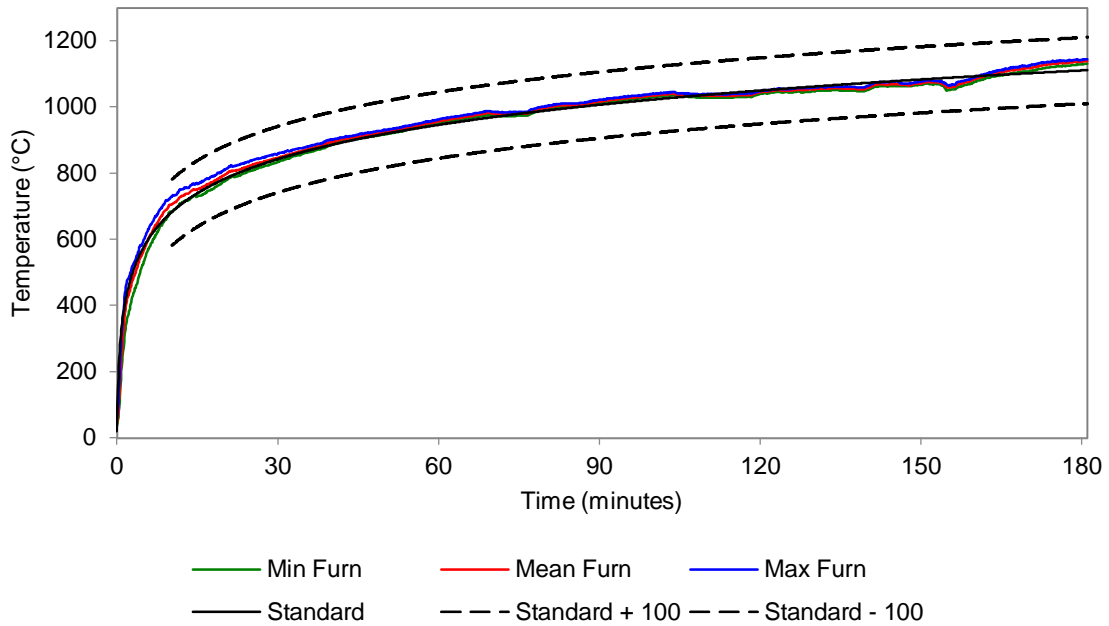

Figure 14 Furnace thermocouple temperature vs time

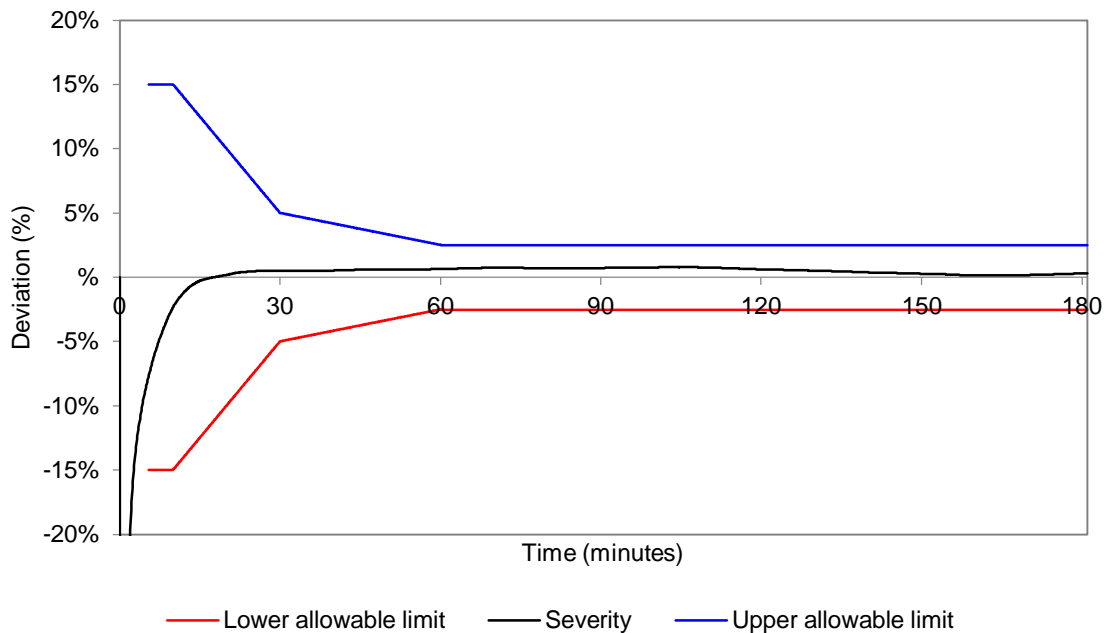

Figure 15 Percentage deviation of exposure severity vs time

## E.2 Furnace pressure

The furnace pressure was measured at the mid height of the vertical control joints.

**Table 11 Furnace pressure**

Time (minutes)	Average pressure (Pa)	Time (minutes)	Average pressure (Pa)	Time (minutes)	Average pressure (Pa)
5-10	16	65-70	16	125-130	15
10-15	14	70-75	15	130-135	15
15-20	15	75-80	15	135-140	15
20-25	15	80-85	14	140-145	14
25-30	14	85-90	17	145-150	15
30-35	15	90-95	17	150-155	16
35-40	16	95-100	14	155-160	15
40-45	16	100-105	15	160-165	15
45-50	16	105-110	15	165-170	17
50-55	15	110-115	17	170-175	15
55-60	16	115-120	16	175-180	14
60-65	14	120-125	15		

### E.3 Specimen temperatures

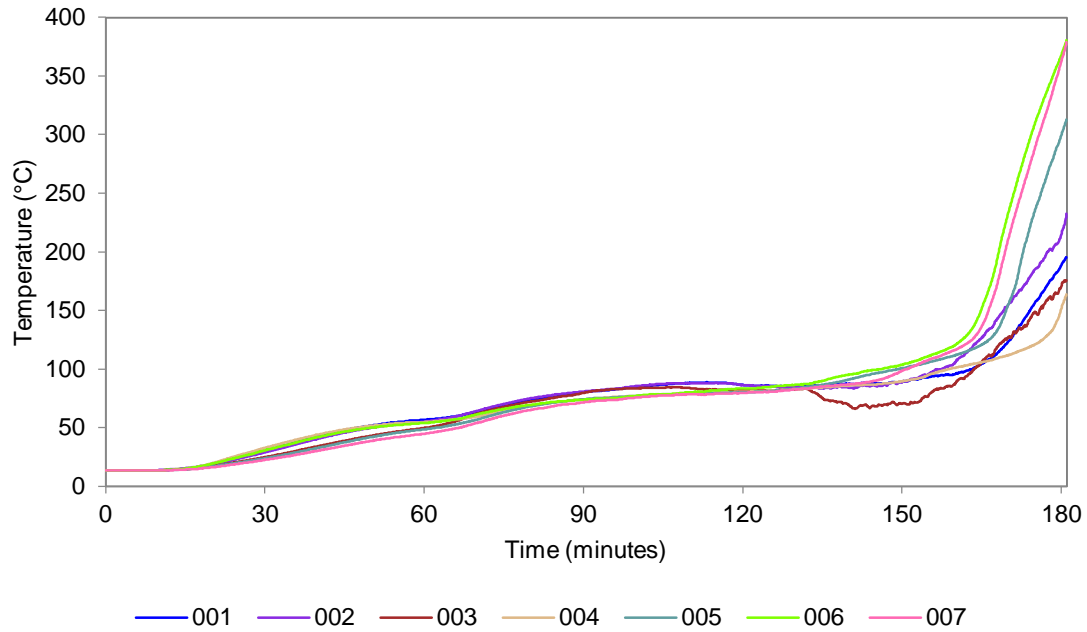

Figure 16 Control joint A – temperature vs time

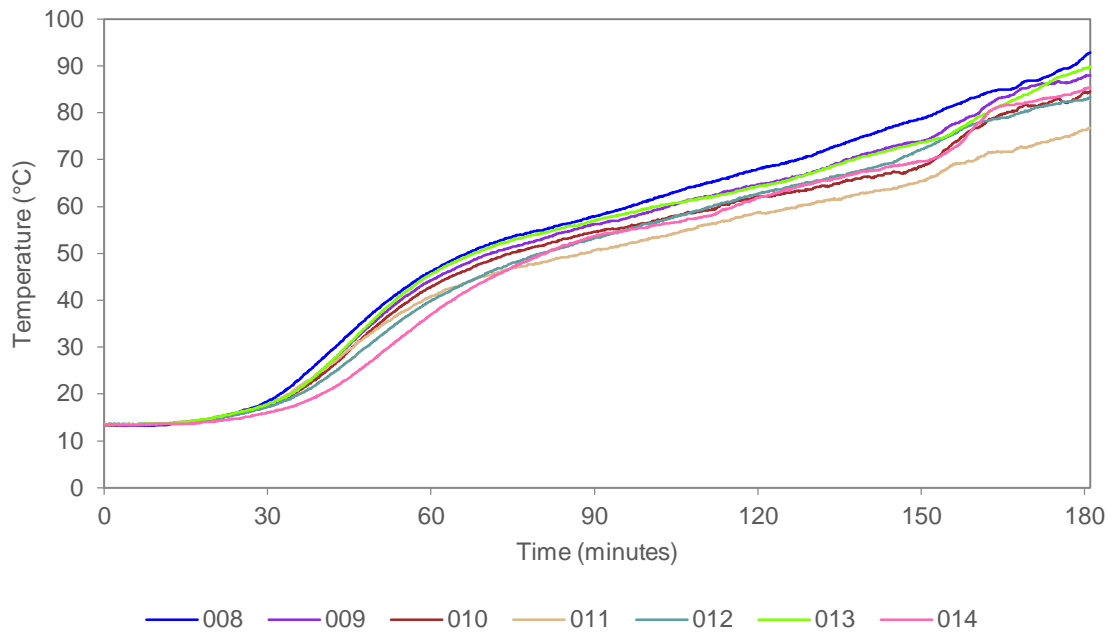

Figure 17 Control joint B – temperature vs time

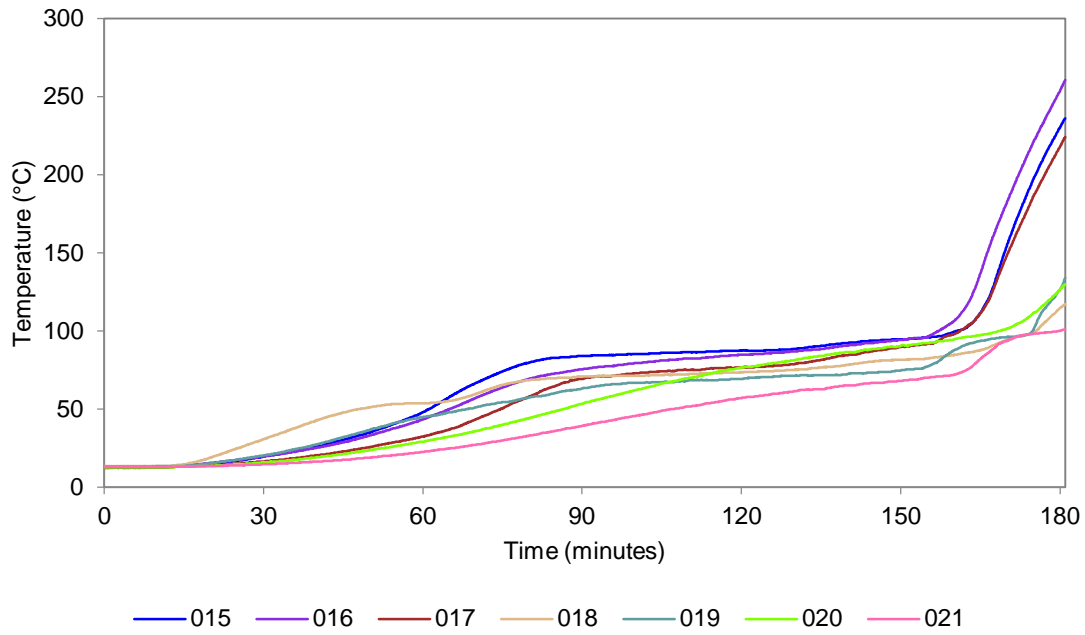

Figure 18 Control joint C – temperature vs time

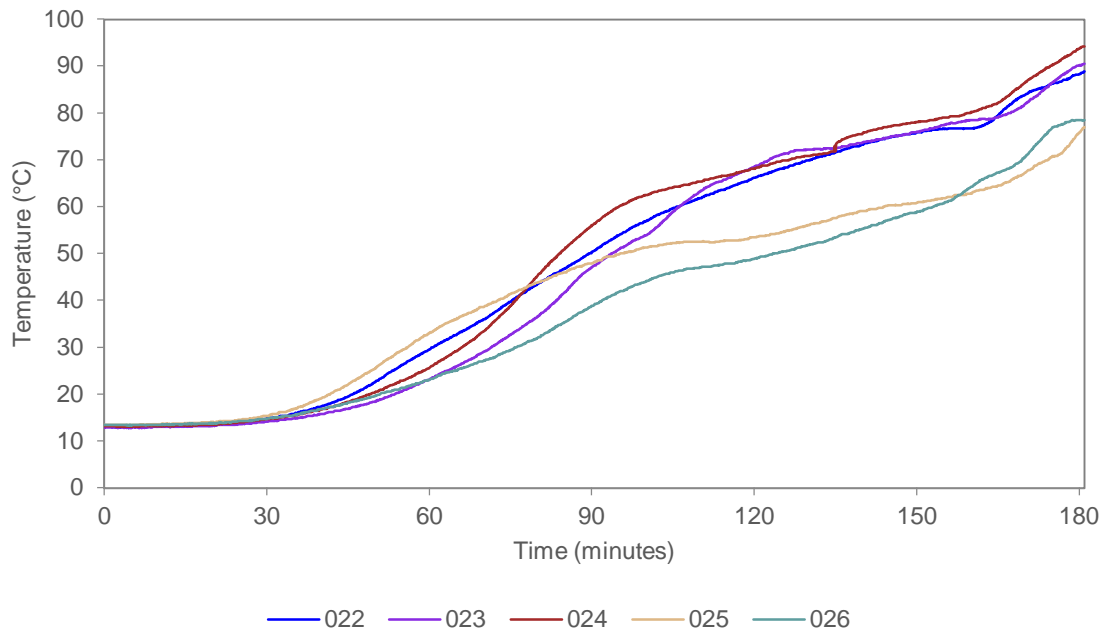

Figure 19 Control joint D – temperature vs time

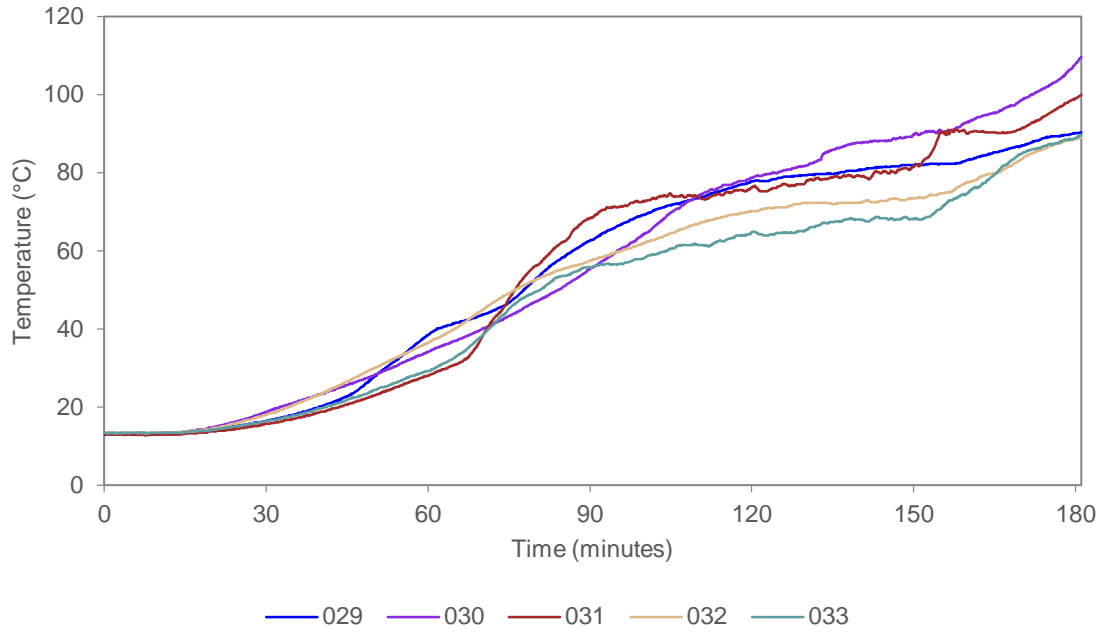

Figure 20 Control joint E – temperature vs time

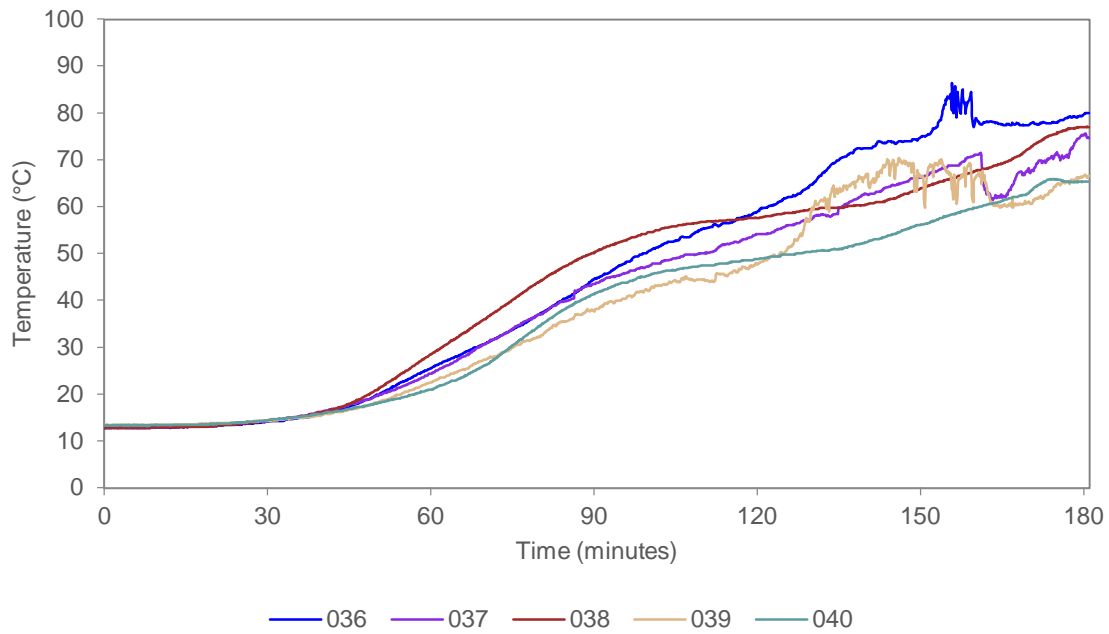

Figure 21 Control joint F – temperature vs time



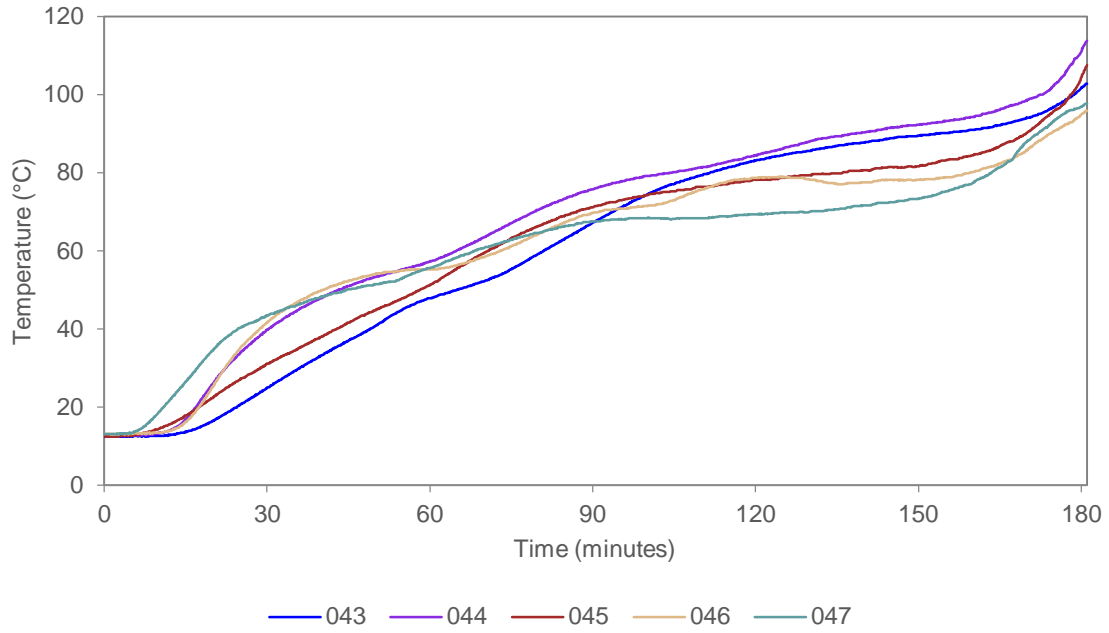

Figure 22 Control joint G – temperature vs time

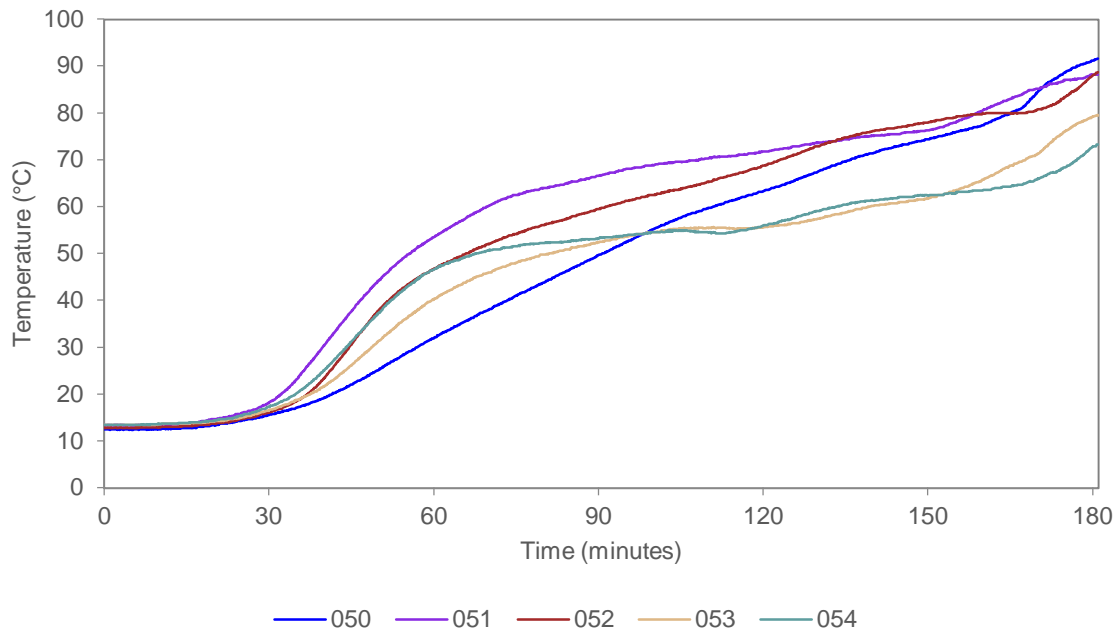

Figure 23 Control joint H – temperature vs time

**Table 12 Test specimen temperatures**

Control joint	T/C #	Description <sup>1</sup>	Temp (°C) at t (minutes)					Limit <sup>2</sup> (minutes)
			t=0	t=60	t=90	t=120	t=180	
A	001	On the control joint	14	56	80	86	188	180
	002	On the control joint	14	55	81	86	214	176
	003	On the control joint	14	50	80	82	170	-
	004	25 mm from the control joint	14	55	74	80	151	-
	005	25 mm from the control joint	14	48	74	80	299	172
	006	25 mm from the control joint	14	54	74	83	368	167
	007	25 mm from the control joint	14	45	72	79	362	169
B	008	On the control joint	13	46	58	68	92	-
	009	On the control joint	13	44	56	65	88	-
	010	On the control joint	14	43	55	62	84	-
	011	25 mm from the control joint	14	41	51	59	76	-
	012	25 mm from the control joint	14	40	53	63	83	-
	013	25 mm from the control joint	14	46	57	64	89	-
	014	25 mm from the control joint	14	37	54	62	85	-
C	015	On the control joint	13	48	84	87	230	174
	016	On the control joint	13	44	75	85	254	171
	017	On the control joint	13	32	69	77	218	176
	018	25 mm from the control joint	13	54	71	74	115	-
	019	25 mm from the control joint	13	45	63	69	127	-
	020	25 mm from the control joint	13	29	53	76	126	-
	021	25 mm from the control joint	13	23	39	57	100	-
D	022	On the control joint	13	30	50	66	88	-
	023	On the control joint	13	23	47	68	90	-
	024	On the control joint	13	26	56	68	94	-
	025	25 mm from the control joint	13	33	48	53	76	-
	026	25 mm from the control joint	13	23	39	49	78	-
E	029	On the control joint	13	38	63	78	90	-
	030	On the control joint	13	34	55	79	108	-
	031	On the control joint	13	28	68	76	99	-
	032	25 mm from the control joint	13	36	57	70	89	-
	033	25 mm from the control joint	13	29	56	65	89	-
F	036	On the control joint	13	26	44	59	80	-
	037	On the control joint	13	24	44	54	75	-
	038	On the control joint	13	28	50	58	77	-
	039	25 mm from the control joint	13	22	38	48	66	-
	040	25 mm from the control joint	13	21	41	49	65	-
G	043	On the control joint	12	48	67	83	102	-
	044	On the control joint	13	57	76	84	111	-

Control joint	T/C #	Description <sup>1</sup>	Temp (°C) at t (minutes)					Limit <sup>2</sup> (minutes)
			t=0	t=60	t=90	t=120	t=180	
	045	On the control joint	13	51	71	78	104	-
	046	25 mm from the control joint	13	55	70	79	95	-
	047	25 mm from the control joint	13	56	68	69	97	-
H	050	On the control joint	12	32	50	63	91	-
	051	On the control joint	13	54	67	72	88	-
	052	On the control joint	13	47	59	69	88	-
	053	25 mm from the control joint	13	40	52	56	79	-
	054	25 mm from the control joint	13	47	53	56	73	-

- Note:**
- <sup>1</sup> Refer to Table 10 for the locations of thermocouples as only a generic description is included in the table.
  - <sup>2</sup> Limit time is the time to the nearest whole minute, rounded down to the nearest minute, at which the temperature recorded by the thermocouple does not rise by more than 180 K above the initial temperature.
  - <sup>3</sup> Under limit column indicates the temperature limit was not exceeded during the test period or up until the time of integrity failure if a failure occurred.

## Appendix F Photographs



Figure 24 Unexposed face of the specimen before the start of the test

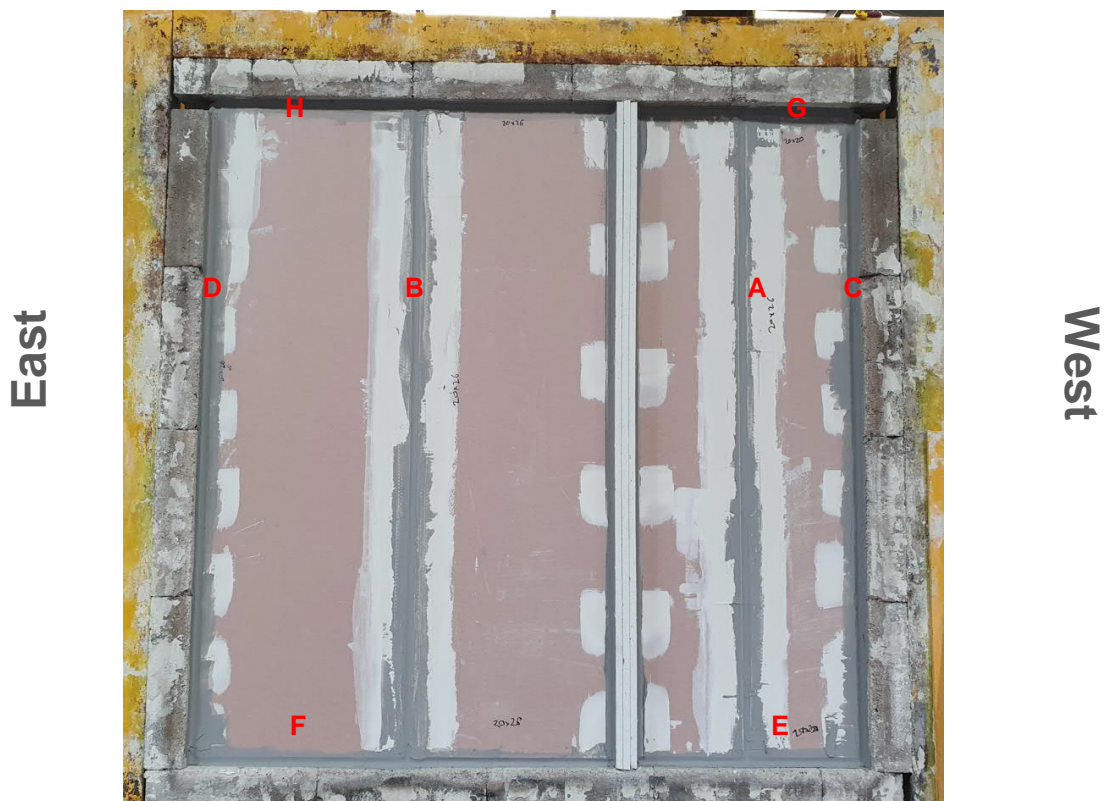
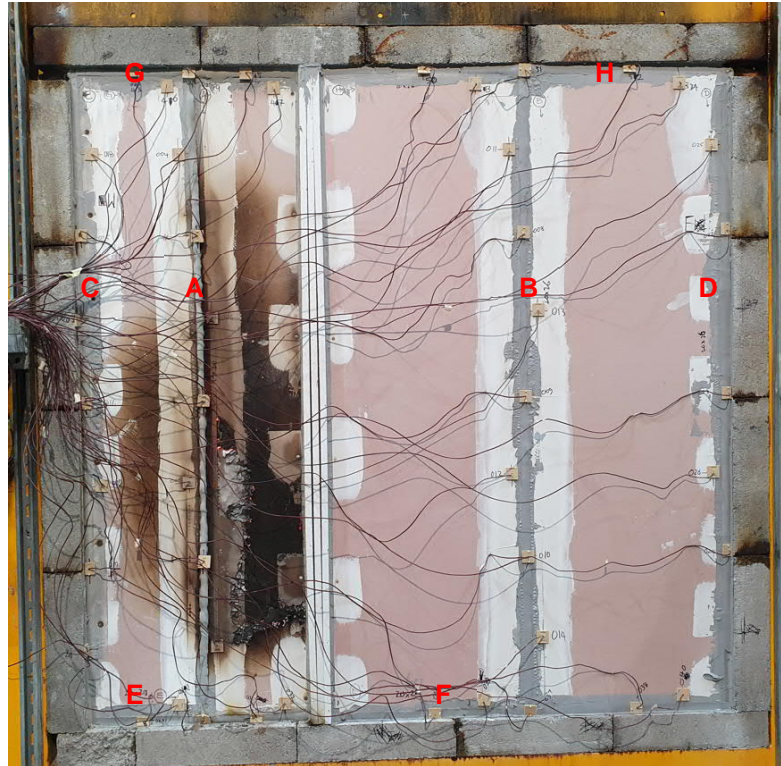

Figure 25 Exposed face of the specimen before the start of the test

West



East

Figure 26 Unexposed face of the specimen at the end of the test

East

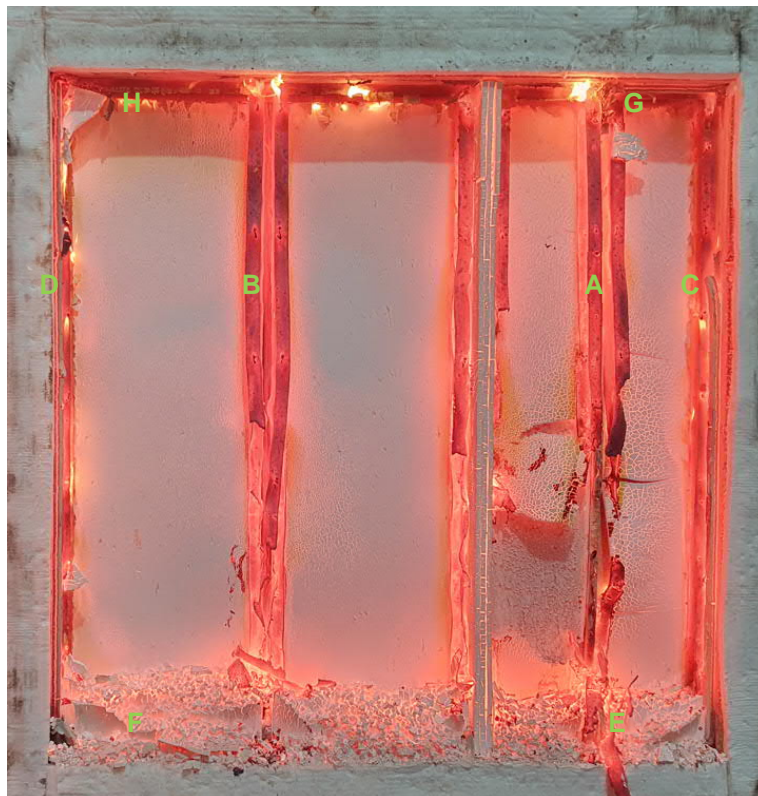

West

Figure 27 Exposed face of the specimen at the end of the test

# Global locations



Warringtonfire Australia Pty Ltd  
ABN 81 050 241 524

#### Perth

Suite 4.01, 256 Adelaide Terrace  
Perth WA 6000  
Australia  
T: +61 8 9382 3844

#### Canberra

Unit 10, 71 Leichhardt Street  
Kingston ACT 2604  
Australia  
T: +61 2 6260 8488

#### Melbourne

Level 4, 152 Elizabeth Street  
Melbourne Vic 3000  
Australia  
T: +61 3 9767 1000

#### Sydney

Suite 802, Level 8, 383 Kent Street  
Sydney NSW 2000  
Australia  
T: +61 2 9211 4333

#### Brisbane

Suite B, Level 6, 133 Mary Street  
Brisbane Qld 4000  
Australia  
T: +61 7 3238 1700

#### Melbourne – NATA accredited laboratory

409-411 Hammond Road  
Dandenong South Vic 3175  
Australia  
T: +61 3 9767 1000